







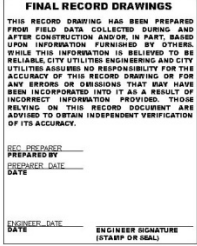

Division 01– General Requirements					
Master Format No.	Description	Type	Symbol	NCS Symbol	File Name (.dwg)
01 00 00	CFW Vicinity Map	Identity		No	010000-001 CFW VIC Map
01 00 00	24x36 Pg. Number for Title Block	Text	SHEET_TYPE_LINE NCS_PAGE_NUMBER OVERALL_PROJECT_PAGE_NUMBER	No	010000-002 24x36 Page Number
01 00 00	CFW Seal	Identity		No	010000-003 CFW Seal
01 00 00	Benchmark Note	Text	<p>BENCHMARK: TYPE LOCATION OF BENCHMARK HERE NORTHING = TYPE NORTHING COORDINATE HERE EASTING = TYPE NORTHING COORDINATE HERE</p>	No	010000-004 Benchmark Note
01 00 00	Contours Disclaimer	Text	<p>NOTE – CONTOUR ELEVATIONS: THE USGS ELEVATION CONTOUR INFORMATION SHOWN ON THESE DRAWINGS IS NOT GUARANTEED TO BE ACCURATE OR ALL-INCLUSIVE. THE ELEVATIONS PROVIDED ARE FOR GENERAL REFERENCE ONLY OF THE SURFACE TOPOGRAPHY. CONTOURS WERE OBTAINED FROM AERIAL PHOTOGRAPHY AND GIS SOURCES.</p>	No	010000-005 Contours Disclaimer

Division 01– General Requirements					
Master Format No.	Description	Type	Symbol	NCS Symbol	File Name (.dwg)
01 00 00	Final record Drawings	Text	 <p>FINAL RECORD DRAWINGS THIS RECORD DRAWING HAS BEEN PREPARED FROM FIELD DATA COLLECTED BEFORE AND AFTER CONSTRUCTION AND/OR, IN PART, BASED UPON INFORMATION FURNISHED BY OTHERS. WHILE THIS INFORMATION IS BELIEVED TO BE RELIABLE, CITY UTILITIES ENGINEERING AND CITY UTILITIES ASSUMES NO RESPONSIBILITY FOR THE ACCURACY OF THIS RECORD DRAWING OR FOR ANY ERRORS OR OMISSIONS THAT MAY HAVE BEEN INCORPORATED INTO IT AS A RESULT OF INCORRECT INFORMATION PROVIDED. THOSE RELYING ON THIS RECORD DOCUMENT ARE ADVISED TO OBTAIN INDEPENDENT VERIFICATION OF ITS ACCURACY. DESIGNER: _____ PREPARED BY: _____ DATE: _____ CHECKED: _____ DATE: _____ ENGINEER SIGNATURE (STAMP OR SEAL)</p>	No	010000-006 Final Record Drawing Note
01 00 00	Holey Moley Call 811	Text	 <p>Indiana 811 Know what's below. Call before you dig.</p>	No	010000-007 Holey Moley Call 811
01 00 00	Plan Design Phase – Horizontal	Text	 <p>CONFORMED TO CONTRACT DRAWING REVISED TO CONFORM TO CONSTRUCTION CONTRACT AS REVISED BY ADDENDUMS BY: CTC, BY NAME _____ DATE: CTC, DATE _____</p>	No	010000-008 Plan Design Phase Horizontal
01 00 00	Plan Design Phase - Vertical	Text	 <p>30% PLANS NOT FOR CONSTRUCTION</p>	No	010000-009 Plan Design Phase Vertical





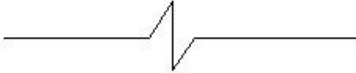
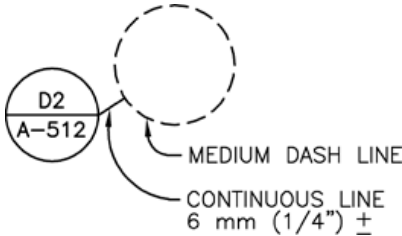

Division 01– General Requirements					
Master Format No.	Description	Type	Symbol	NCS Symbol	File Name (.dwg)
01 00 00	Sheet Quantities	Text	<p><u>SHEET QUANTITIES</u></p> <ul style="list-style-type: none"> * (??) ± L.F. OF 8" WATER MAIN * (??)-8" VALVE * (??)-8"X8" TEE * (??)-8"X8" CROSS * (??)-8"-90° BEND * (??)-8"-45° BEND * (??)-8"-22 1/2° BEND * (??)-8"-11 1/4° BEND * (??)-8"X8" REDUCER * (??)-TYPE III FIRE HYDRANT ASSEMBLY * (??)-TAPS (?? KNOWN, ?? UNKNOWN LOCATIONS) * (??)-6"X8" TAPPING SLEEVE AND VALVE BY WMS * (??)-8"X8" CROSS AND 2-6" VALVES CUT IN BY WMS * (??)-3/4" TEST RISER * (??)-8" PLUG W/ 2" B.O. ASSEMBLY * (??)-CUT & PLUGS * (??)-FIRE HYDRANT ASSEMBLY REMOVALS * (??)-VALVE REMOVALS 	No	010000-010 Sheet QTY
01 00 00	Spatial Relationship Note	Text	<p><u>NOTE:</u></p> <p>ALL BOUNDARY, PROPERTY LINE, RIGHT-OF-WAY, BUILDING, VEGETATION & UTILITY INFORMATION SHOWN ON PLANS IS NOT BASED ON ANY SURVEY OF ANY KIND AND REPRESENTED FOR SPATIAL RELATIONSHIP ONLY.</p>	No	010000-011 Spatial RELAT Note
01 00 00	Traffic Control Legend		<p><u>LEGEND</u></p> <ul style="list-style-type: none"> A. ROAD CONSTRUCTION AHEAD B. ROAD CLOSED AHEAD C. DETOUR AHEAD D. TYPE III BARRICADE WITH ROAD CLOSED LOCAL TRAFFIC ONLY & DETOUR (RIGHT/LEFT) E. DETOUR RIGHT F. DETOUR THRU G. DETOUR LEFT H. TYPE III BARRICADE WITH ROAD CLOSED I. TYPE III BARRICADE J. TYPE III BARRICADE WITH ROAD CLOSED LOCAL TRAFFIC ONLY ^v SIGN ^v BARRICADE 	No	010000-012 TRAF CNTRL Legend





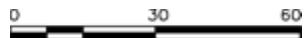
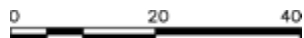
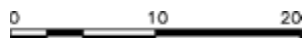

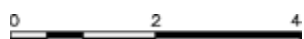
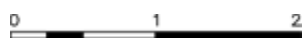
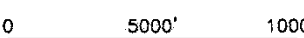

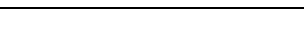
Division 01– General Requirements					
Master Format No.	Description	Type	Symbol	NCS Symbol	File Name (.dwg)
01 00 00	Utilities Disclaimer Note	Text	<p>NOTE-- CAUTION EXISTING UTILITIES:</p> <p>THE INFORMATION SHOWN ON THESE DRAWINGS CONCERNING TYPE AND LOCATION OF UNDERGROUND UTILITIES IS NOT GUARANTEED TO BE ACCURATE OR ALL-INCLUSIVE. LOCATION, SIZE AND MATERIAL SHOWN ON UTILITIES ARE FROM AVAILABLE RECORDS AND AVAILABLE FIELD MARKINGS, SUPPLIED BY THE RESPECTIVE UTILITY COMPANY. THE INDIANA UNDERGROUND PLANT PROTECTION SERVICE (IUPPS) MUST BE NOTIFIED 48 HOURS PRIOR TO ANY EXCAVATION FOR VERIFICATION OF LOCATION, SIZE AND MATERIAL FOR EXISTING UNDERGROUND UTILITIES (1-800-332-5544 OR 811). THE CONTRACTOR SHALL PROMPTLY NOTIFY THE ENGINEER IN WRITING IF ANY UNDERGROUND STRUCTURE OR UTILITY DIFFERS MATERIALLY FROM THE CONDITIONS SHOWN ON THE PLANS AS TO IMPACT THE WORK.</p>	No	010000-013 UTIL Disclaimer Note
01 00 00	Utilities Support Contacts	Text	<p>SANITARY SEWERS CITY OF FORT WAYNE, DIVISION OF UTILITIES PROGRAM MANAGER SEWER CAPACITY AND CSO CITIZENS SQUARE 300 EAST BERRY STREET, SUITE 200 FORT WAYNE, IN 46802 260-427-3069</p> <p>STORMWATER/DRAINAGE -- CITY CITY OF FORT WAYNE, DIVISION OF UTILITIES PROGRAM MANAGER STORMWATER PLANNING AND DESIGN CITIZENS SQUARE 300 EAST BERRY STREET, SUITE 200 FORT WAYNE, IN 46802 260-427-3069</p> <p>POTABLE WATER CITY OF FORT WAYNE, DIVISION OF UTILITIES PROGRAM MANAGER WATER CAPACITY CITIZENS SQUARE 300 EAST BERRY STREET, SUITE 200 FORT WAYNE, IN 46802 260-427-3069</p> <p>WATER MAINTENANCE & SERVICE (WMS) CITY OF FORT WAYNE -- WMS 415 E. WALACE STREET FORT WAYNE, IN 46803 260-427-2475</p> <p>DEVELOPMENT SERVICES CITY OF FORT WAYNE, DIVISION OF UTILITIES CITIZENS SQUARE 300 EAST BERRY STREET, SUITE 130 FORT WAYNE, IN 46802 1-800-427-5044</p> <p>CONSTRUCTION IN CITY STREET OR R.O.W. RD&C OF WAY PERMIT DEPARTMENT OFFICE OF THE CITY ENGINEER CITIZENS SQUARE 300 EAST BERRY STREET, SUITE 210 FORT WAYNE, IN 46802 260-427-1172</p> <p>STREET LIGHTS CITY OF FORT WAYNE -- STREET LIGHTS ENGINEER CITIZENS SQUARE 300 EAST BERRY STREET, SUITE 210 FORT WAYNE, IN 46802 260-427-3767</p> <p>STORMWATER/DRAINAGE -- COUNTY BENCHMARKS, CONNECTIONS AND SURVEYING MONUMENTS ALLEN COUNTY SURVEYOR CITIZENS SQUARE 300 EAST BERRY STREET, SUITE 300 FORT WAYNE, IN 46802 260-445-7822</p> <p>CABLE TELEVISION COMCAST CABLEVISION 793 TWIGG STREET FORT WAYNE, IN 46802 260-426-5167</p> <p>ELECTRIC AMERICAN ELECTRIC POWER CO. 50 ENGINEERING TECHNOLOGY -- FW DISTRICT 3514 LARSON ROAD NEW HAVEN, IN 46774-8440 260-426-1985 260-421-1766</p> <p>NORTHEASTERN RING BRAD DEUTSCH FIELD ENGINEERING SUPERVISOR 4601 EAST PARK 20 DRIVE COLUMBIANA CITY, IN 46723 260-244-6111 ET 427</p> <p>GAS NORTHERN INDIANA PUBLIC SERVICE CO. 1801 HALE AVE. FORT WAYNE, IN 46802 260-426-1221</p> <p>TELEPHONE FRONTIER 8001 W. JEFFERSON BLVD. FORT WAYNE, IN 46834 260-461-2869</p>	No	010000-014 UTIL Support Contacts

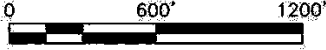
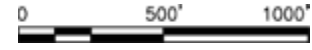
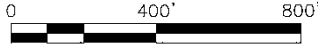

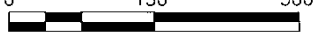

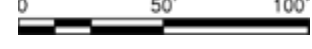
Division 01– General Requirements					
Master Format No.	Description	Type	Symbol	NCS Symbol	File Name (.dwg)
01 00 00	Master Legend	Identity		No	010000-015 Master Legend
01 40 00	Benchmark, elevation indicator, fine line, 4mm (5/32") diameter with lines extending 1mm (1/32") beyond circle	Identity		Yes	014000-001 BM Indicator
01 40 00	Boring indicator	Identity		Yes	014000-002 Boring Indicator





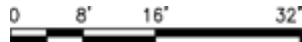
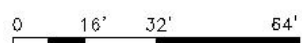
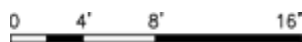

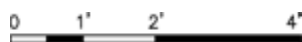
Division 01– General Requirements					
Master Format No.	Description	Type	Symbol	NCS Symbol	File Name (.dwg)
01 40 00	Monument indicator	Identity		Yes	014000-004 MON Indicator
01 40 00	R/W monument	Identity		No	014000-009 RW MON
01 42 00	Break, round (user defines size)	Reference		Yes	014200-018 Break
01 42 00	Break, straight (user defines size)	Reference		Yes	014200-019 Break Straight
01 42 00	Detail indicator, dashed circle, 2.5 mm (3/32") text, typical	Reference		Yes	014200-020 CIRC DET Indicator

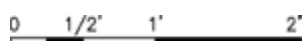

Division 01– General Requirements					
Master Format No.	Description	Type	Symbol	NCS Symbol	File Name (.dwg)
01 42 00	Detail indicator, dashed rectangle, 2.5 mm (3/32") text, typical	Reference		Yes	014200-021 RECT DET Indicator
01 42 00	Detail indicator for small conditions, 45 degree arrow, 2.5 mm (3/32") text, medium line	Reference		Yes	014200-022 Small DET Indicator
01 42 00	Drawing block title, typical	Reference		Yes	014200-026 Title
01 42 00	Elevation indicator, exterior, 16 mm (5/8") diameter	Reference		Yes	014200-27 Elevation Indicator 014200-28 Elevation Indicator
01 42 00	Graphic scale, 1:1000	Reference		Yes	014200-034 Scale 1 to 10000
01 42 00	Graphic scale, 1:500	Reference		Yes	014200-035 Scale 1 to 500

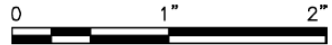
Division 01– General Requirements					
Master Format No.	Description	Type	Symbol	NCS Symbol	File Name (.dwg)
01 42 00	Graphic scale, 1:200	Reference		Yes	014200-036 Scale 1 to 200
01 42 00	Graphic scale, 1:100	Reference		Yes	014200-037 Scale 1 to 100
01 42 00	Graphic scale, 1:50	Reference		Yes	014200-038 Scale 1 to 50
01 42 00	Graphic scale, 1:30	Reference		Yes	014200-039 Scale 1 to 30
01 42 00	Graphic scale, 1:20	Reference		Yes	014200-040 Scale 1 to 20
01 42 00	Graphic scale, 1:10	Reference		Yes	014200-041 Scale 1 to 10
01 42 00	Graphic scale, 1:5	Reference		Yes	014200-042 Scale 1 to 5
01 42 00	Graphic scale, 1:2	Reference		Yes	014200-043 Scale 1 to 2
01 42 00	Graphic scale, 1:1	Reference		Yes	014200-044 Scale 1 to 1
01 42 00	Graphic scale, 1" = 5000'-0"	Reference		No	014200-045 Scale 1 in to 5000 ft
01 42 00	Graphic scale, 1" = 1000'-0"	Reference		Yes	014200-046 Scale 1 in to 1000 ft
01 42 00	Graphic scale, 1" = 800'-0"	Reference		No	014200-047 Scale 1 in to 800 ft



Division 01– General Requirements					
Master Format No.	Description	Type	Symbol	NCS Symbol	File Name (.dwg)
01 42 00	Graphic scale, 1" = 600'-0"	Reference		No	014200-048 Scale 1 in to 600 ft
01 42 00	Graphic scale, 1" = 500'-0"	Reference		Yes	014200-049 Scale 1 in to 500 ft
01 42 00	Graphic scale, 1" = 400'-0"	Reference		No	014200-050 Scale 1 in to 400 ft
01 42 00	Graphic scale, 1" = 300'-0"	Reference		No	014200-051 Scale 1 in to 300 ft
01 42 00	Graphic scale, 1" = 200'-0"	Reference		Yes	014200-052 Scale 1 in to 200 ft
01 42 00	Graphic scale, 1" = 150'-0"	Reference		No	014200-053 Scale 1 in to 150 ft
01 42 00	Graphic scale, 1" = 100'-0"	Reference		Yes	014200-054 Scale 1 in to 100 ft
01 42 00	Graphic scale, 1" = 50'-0"	Reference		Yes	014200-055 Scale 1 in to 50 ft
01 42 00	Graphic scale, 1" = 40'-0"	Reference		Yes	014200-056 Scale 1 in to 40 ft
01 42 00	Graphic scale, 1" = 30'-0"	Reference		Yes	014200-057 Scale 1 in to 30 ft
01 42 00	Graphic scale, 1" = 20'-0"	Reference		Yes	014200-058 Scale 1 in to 20 ft

Division 01– General Requirements					
Master Format No.	Description	Type	Symbol	NCS Symbol	File Name (.dwg)
01 42 00	Graphic scale, 1" = 10'-0"	Reference		Yes	014200-059 Scale1 in to 10 ft
01 42 00	Graphic scale, 1/16" = 1'-0"	Reference		Yes	014200-060 Scale 1-16 in to 1 ft
01 42 00	Graphic scale, 3/32" = 1'-0"	Reference		Yes	014200-061 Scale 3-32 in to 1 ft
01 42 00	Graphic scale, 1/8" = 1'-0"	Reference		Yes	014200-062 Scale 1-8 in to 1 ft
01 42 00	Graphic scale, 1/4" = 1'-0"	Reference		Yes	014200-063 Scale 1-4 in to 1 ft
01 42 00	Graphic scale, 3/8" = 1'-0"	Reference		Yes	014200-064 Scale 3-8 in to 1 ft
01 42 00	Graphic scale, 1/2" = 1'-0"	Reference		Yes	014200-065 Scale 1-2 in to 1 ft
01 42 00	Graphic scale, 3/4" = 1'-0"	Reference		Yes	014200-066 Scale 3-4 in to 1 ft
01 42 00	Graphic scale, 1" = 1'-0"	Reference		Yes	014200-067 Scale 1 in to 1 ft

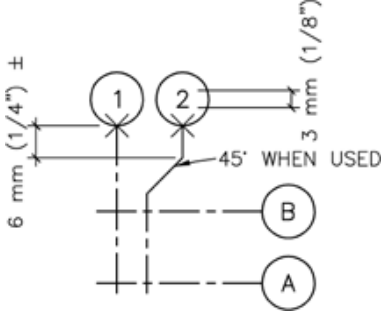
Division 01– General Requirements					
Master Format No.	Description	Type	Symbol	NCS Symbol	File Name (.dwg)
01 42 00	Graphic scale, 1 ½" = 1'-0"	Reference		Yes	014200-068 Scale 1.5 in to 1 ft
01 42 00	Graphic scale, 3" = 1'-0"	Reference		Yes	014200-069 Scale 3 in to 1 ft
01 42 00	Graphic scale, 6" = 1'-0"	Reference		Yes	014200-070 Scale 6 in to 1 ft
01 42 00	Graphic scale, 1" = 1"	Reference		Yes	014200-071 Scale 1 in to 1 in
01 42 00	Identification device indicator, 2 mm (5/64") text, 3 mm (1/8") sides	Reference		Yes	014200-072 ID Device Indicator
01 42 00	Insertion point, 4 mm (5/32") wide/high hidden line	Reference		Yes	014200-073 Insertion Point
01 42 00	Keynote indicator, 2.5 mm (3/32") text, 60 degree angles, 6 mm (1/4") high, medium line	Reference		Yes	014200-074 Keynote Indicator

Division 01– General Requirements					
Master Format No.	Description	Type	Symbol	NCS Symbol	File Name (.dwg)
01 42 00	Louver type identifier, L = louver, 3 = type, similar to window type identifier, medium line	Reference		Yes	014200-075 LVR Type
01 42 00	North Arrow, 1.5" long on full size, ARCH D Sheets	Reference		No	014200-076 North Arrow
01 42 00	Reference grid indicator with reference grid lines, medium line, typical	Reference		Yes	014200-077 REF Indicator



Division 01– General Requirements					
Master Format No.	Description	Type	Symbol	NCS Symbol	File Name (.dwg)
01 42 00	Revision indicator (shown with revision cloud), typical	Reference		Yes	014200-078 REV Indicator
01 42 00	Room identifier with room name and number, medium line, typical	Reference		Yes	014200-079 Room ID
01 42 00	Room identifier with room name and number, optional finishes A = floor finish type 2 = base finish type C = wall finish type 3 = ceiling finish type	Reference		Yes	014200-080 Room ID

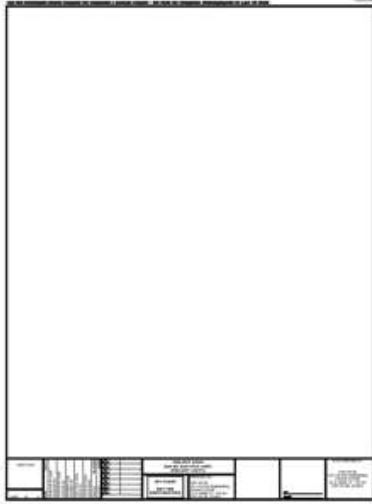

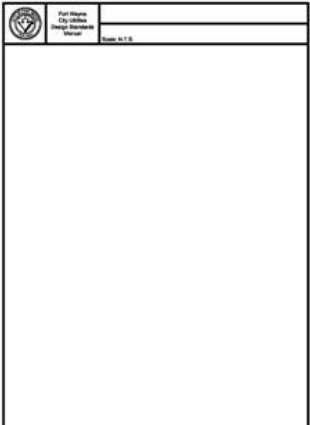
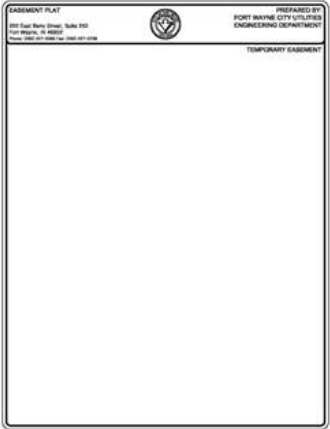
Division 01– General Requirements					
Master Format No.	Description	Type	Symbol	NCS Symbol	File Name (.dwg)
01 42 00	Iron Pin, Property corner indicator, (3/16") diameter	Identity		No	014200-081 Iron Pin
01 42 00	Match-Line	Reference		No	014200-082 Matchline

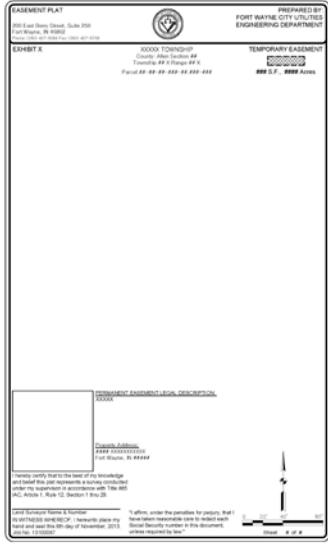
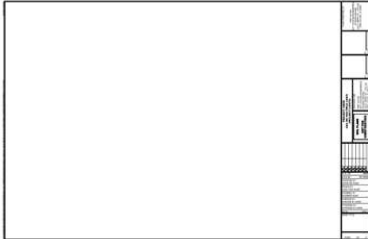
Division 01– General Requirements					
Master Format No.	Description	Type	Symbol	NCS Symbol	File Name (.dwg)
01 42 00	8 X 11 Portrait Title Block Border	Reference		No	014200-083 8_5x11 LAN TTLB
01 42 00	8 X 11 Landscape Title Block Border	Reference		No	014200-084 8_5X11 POR TTLB

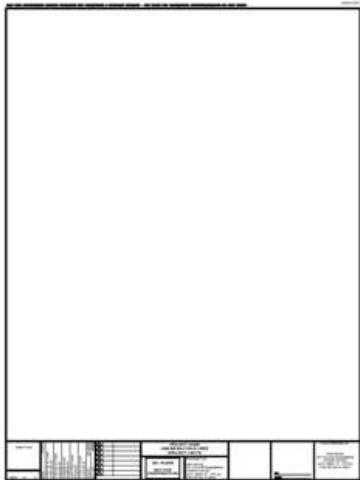
Division 01– General Requirements					
Master Format No.	Description	Type	Symbol	NCS Symbol	File Name (.dwg)
01 42 00	8 x 11 Portrait Detail Title Block Border	Reference		No	014200-085 8_5x11 POR DET TTLB
01 42 00	8 x 11 Temporary Easement Title Block Border	Reference		No	014200-086 8_5x11 TEMP EASE TTLB

Division 01– General Requirements					
Master Format No.	Description	Type	Symbol	NCS Symbol	File Name (.dwg)
01 42 00	8 x 14 Permanent Easement Title Block Border	Reference	 <p>The image shows a detailed title block for an 'EASEMENT PLAT'. It includes project information such as 'PROJECTED BY: FORT WAYNE CITY UTILITIES ENGINEERING DEPARTMENT', 'DATE: 08/14/2008', and 'DRAWN BY: J. J. JONES'. It also contains a 'PROPERTY ADDRESS' section and a 'NOTICE' section. The title block is enclosed in a rectangular border.</p>	No	014200-087 8_5x14 PERM EASE TTLB
01 42 00	11 x 17 Title Block Border	Reference	 <p>The image shows a rectangular title block border with a vertical column of text on the right side. The text includes 'PROJECT INFORMATION', 'PROPERTY ADDRESS', and 'NOTICE'. The border is simple and clean.</p>	No	014200-088 11x17 TTLB

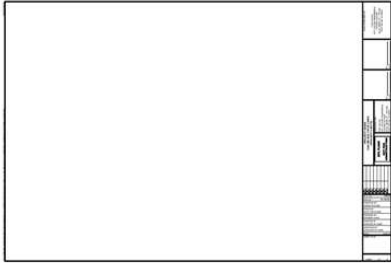

Division 01– General Requirements					
Master Format No.	Description	Type	Symbol	NCS Symbol	File Name (.dwg)
01 42 00	48X36 Title Block Border	Reference		No	014200-089 48x36 TTLB
01 42 00	17 x 22 Title Block Border	Reference		No	014200-090 17x22 TTLB

Division 01– General Requirements					
Master Format No.	Description	Type	Symbol	NCS Symbol	File Name (.dwg)
01 42 00	24 x 36 Title Block Border	Reference		No	014200-091 24x36 TTLB
01 42 00	22 x 34 Title Block Border	Reference		No	014200-092 22x34 TTLB
01 00 00	And	Text	&	Yes	N/A
01 00 00	At	Text	@	Yes	N/A
01 00 00	Center line	Text	Ⓞ	Yes	N/A



Division 01– General Requirements					
Master Format No.	Description	Type	Symbol	NCS Symbol	File Name (.dwg)
01 00 00	Degree(s)	Text	X°	Yes	N/A
01 00 00	Divide by, per	Text	/	Yes	N/A
01 00 00	Dollar (USD)	Text	\$	Yes	N/A
01 00 00	Equals, equal to	Text	=	Yes	N/A
01 00 00	Foot, feet	Text	X'	Yes	N/A
01 00 00	Greater than	Text	>	Yes	N/A
01 00 00	Greater than or equal to	Text	≥	Yes	N/A

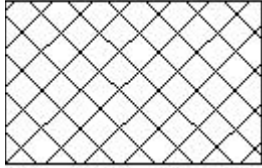
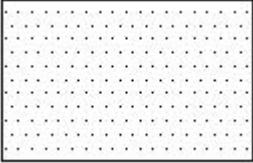

Division 01– General Requirements					
Master Format No.	Description	Type	Symbol	NCS Symbol	File Name (.dwg)
01 00 00	Inch(es)	Text	X”	Yes	N/A
01 00 00	Less than	Text	<	Yes	N/A
01 00 00	Less than or equal to	Text	≤	Yes	N/A
01 00 00	Minus	Text	—	Yes	N/A
01 00 00	Multiply by, by	Text	X	Yes	N/A
01 00 00	Number, pound	Text	#	Yes	N/A
01 00 00	Percent	Text	%	Yes	N/A





Division 01– General Requirements					
Master Format No.	Description	Type	Symbol	NCS Symbol	File Name (.dwg)
01 00 00	Plus	Text	+	Yes	N/A
01 00 00	Plus or minus	Text	+/- or ±	Yes	N/A
01 00 00	Property line	Text	ℙ	Yes	N/A
01 42 00	Center line indicator; thin line, 2 mm (5/64") dash, 2 mm (5/64") space	Line	— — — — —	Yes	N/A
01 42 00	Contract limit line; wide line with dot, 1 mm (1/16") diameter dot, 3 mm (1/8") space	Line	— — — — —	Yes	N/A
01 42 00	Demolition line; medium line, 4 mm (5/32") dash, 2 mm (5/64") space	Line	— — — — —	Yes	N/A
01 42 00	Hidden features line; thin line	Line	— — — — —	Yes	N/A

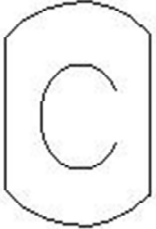

Division 01– General Requirements					
Master Format No.	Description	Type	Symbol	NCS Symbol	File Name (.dwg)
01 42 00	Property line	Line	———— PL ————	No	N/A
01 42 00	Right-of-Way Line	Line	———— R/W ————	No	N/A
01 42 00	Easement line	Line	———— ESMT ————	No	N/A
01 42 00	Resurfacing, Others	Material		No	N/A
01 42 00	Proposed pavement	Material		No	N/A
01 42 00	Removal	Material		No	N/A

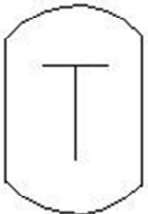
Division 01– General Requirements					
Master Format No.	Description	Type	Symbol	NCS Symbol	File Name (.dwg)
01 42 00	Elevation indicator, interior, multiple view, 16 mm (5/8") diameter; for two, three or four views	Reference		Yes	014200-029 Elevation Indicator
01 42 00	Elevation indicator, interior, single view, 16 mm (5/8") diameter	Reference		Yes	014200-030 Elevation Indicator

Division 02 – Existing Conditions					
Master Format No.	Description	Type	Symbol	NCS Symbol	File Name (.dwg)
02 21 00	Finish floor	Identity		No	202100-001 Finish Floor
02 21 00	PK nail	Identity		No	022100-002 PK Nail
02 21 00	Chiseled X (Marking)	Identity		No	022100-003 Chiseled X



Division 03 - Concrete					
Master Format No.	Description	Type	Symbol	NCS Symbol	File Name (.dwg)
03 30 00	Concrete	Material		Yes	N/A
03 48 00	Precast concrete, communications vault	Identity		Yes	034800-001 PCC COMM Vault
03 48 00	Precast concrete, electrical vault	Identity		Yes	034800-002 PCC ELEC Vault
03 48 00	Precast concrete, manhole, transformer vault	Identity		Yes	034800-004 PCC MH Vault

03 48 00	Precast concrete, telephone vault	Identity		Yes	034800-005 PCC TELE Vault
03 48 00	Precast concrete, transformer pad	Identity		Yes	034800-006 PCC XFMR Pad
03 48 00	Precast concrete, vault, natural gas valve	Identity		Yes	034800-007 PCC G Vault
03 48 00	Air Release Valve Vault	Identity		No	034800-008 Air Release Vault

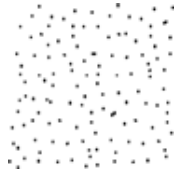
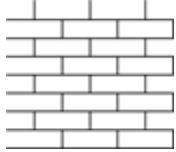

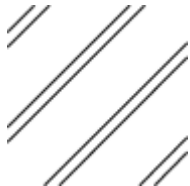

03 48 00	Combination air release valve vault	Identity		No	034800-009 Combo Air Release Vault
03 48 00	Traffic Vault	Identity		No	034800-010 Traffic Vault





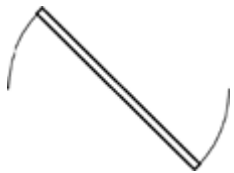

Division 04 - Masonry					
Master Format No.	Description	Type	Symbol	NCS Symbol	File Name (.dwg)
04 05 00	Grout	Material		Yes	N/A
04 21 00	Brick elevation, running bond	Material		Yes	N/A

Division 05– Metals					
Master Format No.	Description	Type	Symbol	NCS Symbol	File Name (.dwg)
05 05 00	Aluminum	Material		Yes	N/A
05 05 00	Steel and other metals	Material		Yes	N/A

Division 06—Woods, Plastics, and Composites					
Master Format No.	Description	Type	Symbol	NCS Symbol	File Name (.dwg)
06 20 00	Wood finish	Material		Yes	N/A
06 44 00	Column	Identity		No	064400-001 Column





Division 07 – Thermal and Moisture Protection					
Master Format No.	Description	Type	Symbol	NCS Symbol	File Name (.dwg)
07 71 00	Downspout	Identity		No	077100-001 Downspout

Division 08—Openings					
Master Format No.	Description	Type	Symbol	NCS Symbol	File Name (.dwg)
08 10 00	Door, center pivot	Object		Yes	081000-003 Door CNTR
08 10 00	Door, double	Object		Yes	081000-004 Door Double
08 10 00	Door, double swing	Object		Yes	081000-006 SWDR DBL
08 10 00	Door, single full swing	Object		Yes	081000-009 SWDR SGL Full
08 10 00	Door, single hinged or pivot	Object		Yes	081000-010 Door SGL Hinged



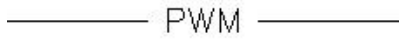
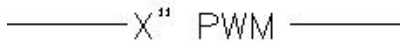

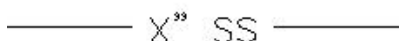
Division 10—Specialties					
Master Format No.	Description	Type	Symbol	NCS Symbol	File Name (.dwg)
10 14 00	One Post Sign	Indicator		No	101400-001 One post Sign
10 14 00	Barricade, 2 post sign	Indicator		No	101400-002 Two post Barricade
10 14 00	Traffic Control Barricade	Identity	 Barricade ID	No	101400-003 Traffic Control Barricade
10 14 00	Traffic Control Sign	Identity	 Sign ID	No	101400-004 Traffic Control Sign
10 17 00	Pay phone	Identity		No	101700-001 Pay Phone
10 55 00	Mailbox	Indicator		No	105500-001 Mailbox
10 75 00	Flag Pole	Identity	 FLAG POLE	No	107500-001 Flag Pole

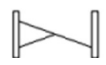
Division 11 – Equipment					
Master Format No.	Description	Type	Symbol	NCS Symbol	File Name (.dwg)
11 12 00	Parking meter	Identity		No	111200-001 Parking Meter

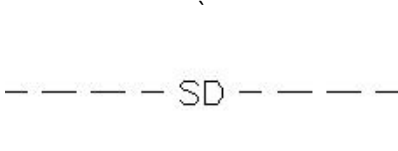
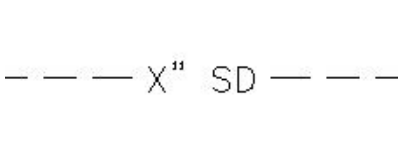
Division 21 – Fire Suppression					
Master Format No.	Description	Type	Symbol	NCS Symbol	File Name (.dwg)
21 13 00	Automatic sprinkler	Identity		No	211300-001 ASKLR





Division 22-Plumbing					
Master Format No.	Description	Type	Symbol	NCS Symbol	File Name (.dwg)
22 11 00	Water main, private, Unknown size	Line		Yes	N/A
22 11 00	Water main, private, known size	Line		Yes	N/A
22 11 00	Waste line, sanitary soil (below floor = SS); thin line, 2.5 mm (3/32") text, Unknown size	Line		Yes	N/A
22 11 00	Waste line, sanitary soil, thin line, 2.5mm (3/32") text, Known size	Line		No	N/A
22 13 00	Sanitary Valve	Identity		No	221300-001 SAN Valve
22 13 00	Check Valve	Identity		No	221300-002 Check Valve

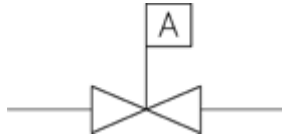
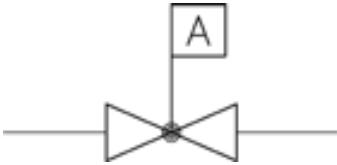
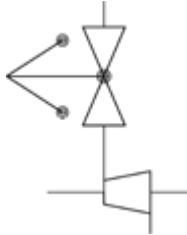
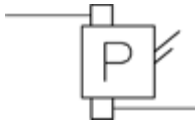

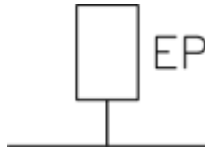
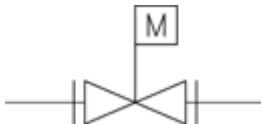
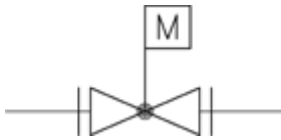
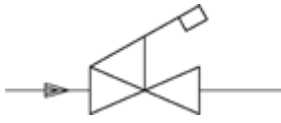
22 14 00	Drain line, storm (below floor); thin line, 2.5 mm (3/32") text, Unknown size	Line		Yes	N/A
22 14 00	Drain line, storm (below floor); thin line, 2.5mm (3/32") text, Known size	Line		Yes	N/A

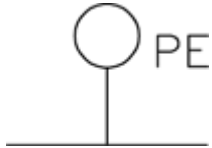

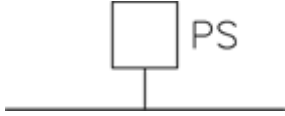
Division 23 –Heating, Ventilating, and Air Conditioning					
Master Format No.	Description	Type	Symbol	NCS Symbol	File Name (.dwg)
23 09 00	Air distribution, controller, liquid level	Identity		Yes	230900-001 Air CONT
23 09 00	Air distribution, damper control, electric operated	Identity		Yes	230900-002 Air DMPR Control
23 09 00	Air distribution, duct detector	Identity		Yes	230900-003 Air Duct Detector
23 09 00	Air distribution, pneumatic operated damper control	Identity		Yes	230900-004 Air PNEU Damper
23 09 00	Control panel for heating, ventilating and air conditioning	Identity		Yes	230900-005 Control PNL HVAC



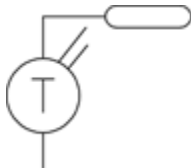
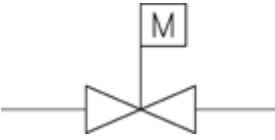
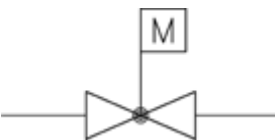

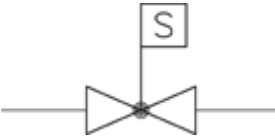
Division 23 –Heating, Ventilating, and Air Conditioning					
Master Format No.	Description	Type	Symbol	NCS Symbol	File Name (.dwg)
23 09 00	HVAC control, air motor controlled gate valve	Identity		Yes	230900-006 HVAC Gate Valve
23 09 00	HVAC control, air motor controlled globe valve	Identity		Yes	230900-007 HVAC Globe Valve
23 09 00	HVAC control, automatic governor operated valve	Identity		Yes	230900-008 HVAC Auto Valve
23 09 00	HVAC control, differential oil pressure switch	Identity		Yes	230900-009 HVAC OPRS Swch

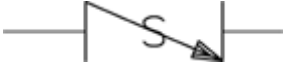
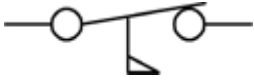
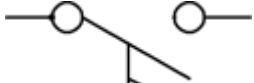

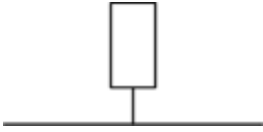

Division 23 –Heating, Ventilating, and Air Conditioning					
Master Format No.	Description	Type	Symbol	NCS Symbol	File Name (.dwg)
23 09 00	HVAC control, dual pressure switch	Identity		Yes	230900-010 HVAC Dual PRESS SWCH
23 09 00	HVAC control, electric pneumatic control	Identity		Yes	230900-011 ELEC PNEU Control
23 09 00	HVAC control, flanged motor operated gate valve	Identity		Yes	230900-012 FLG MOT Gate Valve
23 09 00	HVAC control, flanged motor operated globe valve	Identity		Yes	230900-013 Flanged MOT Globe Valve
23 09 00	HVAC control, fusible link quick valve	Identity		Yes	230900-014 FUS LINK Quick Valve

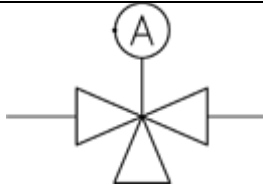

Division 23 –Heating, Ventilating, and Air Conditioning					
Master Format No.	Description	Type	Symbol	NCS Symbol	File Name (.dwg)
23 09 00	HVAC control, pneumatic electric control	Identity		Yes	230900-015 PNEU ELEC CNTRL
23 09 00	HVAC control, pressure stat	Identity		Yes	230900-016 HVAC PRES STAT
23 09 00	HVAC control, pressure switch, type 1	Identity		Yes	230900-017 PRESS SWCH Type1
23 09 00	HVAC control, pressure switch, type 2	Identity		Yes	230900-018 PRESS SWCH Type2
23 09 00	HVAC control, pressure switch with high pressure cutout	Identity		Yes	230900-019 PRESS SWCH CO

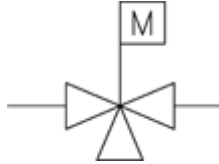

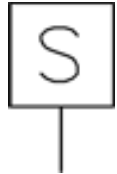

Division 23 –Heating, Ventilating, and Air Conditioning					
Master Format No.	Description	Type	Symbol	NCS Symbol	File Name (.dwg)
23 09 00	HVAC control, remote bulb thermostat	Identity		Yes	230900-020 Remote Bulb TSTAT
23 09 00	HVAC control, screwed motor operated gate valve	Identity		Yes	230900-021 Screwed Operated Gate Valve
23 09 00	HVAC control, screwed motor operated globe valve	Identity		Yes	230900-022 Screwed operated Globe Valve
23 09 00	HVAC control, self-contained thermostat	Identity		Yes	230900-023 Self-Contained Thermostat
23 09 00	HVAC control, solenoid valve	Identity		Yes	230900-024 HVAC SOLV

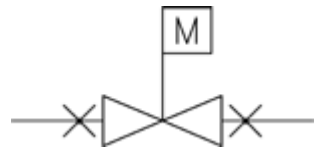
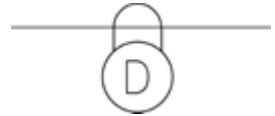
Division 23 –Heating, Ventilating, and Air Conditioning					
Master Format No.	Description	Type	Symbol	NCS Symbol	File Name (.dwg)
23 09 00	HVAC control, spring check valve	Identity		Yes	230900-025 Spring CHKV
23 09 00	HVAC control, switch, normally closed flow	Identity		Yes	230900-026 SWCH Closed Flow
23 09 00	HVAC control, switch, normally open flow	Identity		Yes	230900-027 SWCH Open Flow
23 09 00	HVAC control, thermal bulb	Identity		Yes	230900-028 ThermalBulb
23 09 00	HVAC control, thermometer	Identity		Yes	230900-029 Thermometer





Division 23 –Heating, Ventilating, and Air Conditioning					
Master Format No.	Description	Type	Symbol	NCS Symbol	File Name (.dwg)
23 09 00	HVAC control, thermometer well	Identity		Yes	230900-030 Thermometer Well
23 09 00	HVAC control, thermostat, electric	Identity		Yes	230900-031 ELEC Thermostat
23 09 00	HVAC control, thermostat, pneumatic	Identity		Yes	230900-032 PNEU TSTAT
23 09 00	HVAC control, thermostat, self-contained	Identity		Yes	230900-033 SelfContained TSTAT
23 09 00	HVAC control, three-way air motor controlled valve	Identity		Yes	230900-034 ThreeWay Air MOT Valve

Division 23 –Heating, Ventilating, and Air Conditioning					
Master Format No.	Description	Type	Symbol	NCS Symbol	File Name (.dwg)
23 09 00	HVAC control, three-way electric motor controlled valve	Identity		Yes	230900-035 Threeway ELEC MOT Valve
23 09 00	HVAC control, valve actuator electric motor	Identity		Yes	230900-036 Valve Actuator ELEC MOT
23 09 00	HVAC control, valve actuator electric solenoid	Identity		Yes	230900-037 Valve Actuator ELEC Solenoid
23 09 00	HVAC control, valve actuator pneumatic motor	Identity		Yes	230900-038 Valve Actuator Pneumatic Motor
23 09 00	HVAC control, valve actuator pneumatic motor diaphragm	Identity		Yes	230900-039 Valve Actuator Motor Diaphragm



Division 23 –Heating, Ventilating, and Air Conditioning					
Master Format No.	Description	Type	Symbol	NCS Symbol	File Name (.dwg)
23 09 00	HVAC control, vapor regulated suction valve	Identity		Yes	230900-040 Vapor Regulated Suction Valve
23 09 00	HVAC control, welded motor operated gate valve	Identity		Yes	230900-041 Welded MOT Gate Valve
23 10 00	Piping, engine (indicate fuel)	Identity		Yes	231000-001 Piping Engine
23 10 00	Piping, gas turbine	Identity		Yes	231000-002 Piping Gas Turbine
23 11 00	Fire suppression, LP gas shutoff	Identity		Yes	231100-001 LP Gas Shutoff

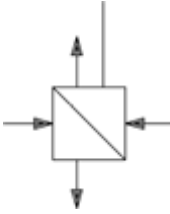

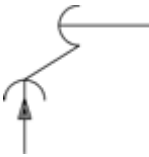

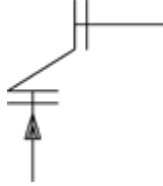
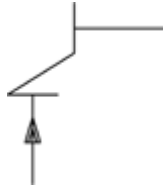
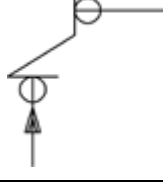
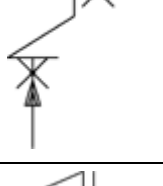
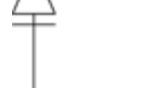
Division 23 –Heating, Ventilating, and Air Conditioning					
Master Format No.	Description	Type	Symbol	NCS Symbol	File Name (.dwg)
23 11 00	Fire suppression, natural gas shutoff	Identity		Yes	231100-002 G Shutoff
23 11 00	Fuel oil, discharge line = FOD; thin line, 2.5 mm (3/32") text	Line		Yes	N/A
23 11 00	Fuel oil, flow line = FOF; thin line, 2.5 mm (3/32") text	Line		Yes	N/A
23 11 00	Fuel oil, gauge line = FOG; 2.5 mm (3/32") text	Line		Yes	N/A
23 11 00	Fuel oil, return line = FOR; thin line, 2.5 mm (3/32") text	Line		Yes	N/A

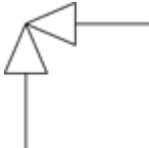
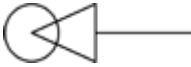

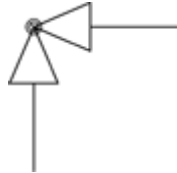
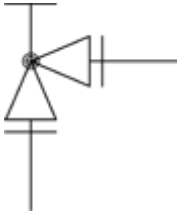

Division 23 –Heating, Ventilating, and Air Conditioning					
Master Format No.	Description	Type	Symbol	NCS Symbol	File Name (.dwg)
23 11 00	Fuel oil, suction supply line = FOS; thin line, 2.5 mm (3/32") text	Line	———— FOS ————	Yes	N/A
23 11 00	Fuel oil, tank vent line = FOV; thin line, 2.5 mm (3/32") text	Line	———— FOV ————	Yes	N/A
23 11 00	Gas line, high pressure = HG; thin line, 2.5 mm (3/32") text	Line	———— HG ————	Yes	N/A
23 11 00	Gas line, liquid petroleum = LPG; thin line, 2.5 mm (3/32") text	Line	———— LPG ————	Yes	N/A
23 11 00	Gas line, low pressure = G; thin line, 2.5 mm (3/32") text	Line	———— G ————	Yes	N/A

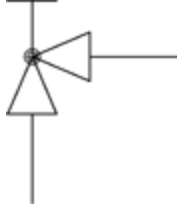
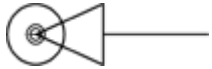

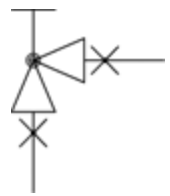

Division 23 –Heating, Ventilating, and Air Conditioning					
Master Format No.	Description	Type	Symbol	NCS Symbol	File Name (.dwg)
23 11 00	Gas line, medium pressure = MG; thin line, 2.5 mm (3/32") text	Line		Yes	N/A
23 13 00	Storage tank, facility fuel storage	Identity		Yes	231300-001 FACIL FOTK
23 20 00	Heater, live steam superheater	Identity		Yes	232000-001 Live Steam Heater
23 20 00	Piping, anchor intermediate	Identity		Yes	232000-002 Piping Anchor Intermediate
23 20 00	Piping, anchor main	Identity		Yes	232000-003 Piping Anchor Main
23 20 00	Piping, angle check valve, bell & spigot	Identity		Yes	232000-004 Piping Angle CHKV B&S



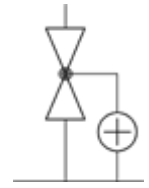
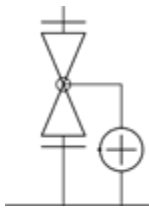

Division 23 –Heating, Ventilating, and Air Conditioning					
Master Format No.	Description	Type	Symbol	NCS Symbol	File Name (.dwg)
23 20 00	Piping, angle check valve, flanged	Identity		Yes	232000-005 Piping Angle CHKV Flanged
23 20 00	Piping, angle check valve, screwed	Identity		Yes	232000-006 Piping Angle CHKV Screwed
23 20 00	Piping, angle check valve, soldered	Identity		Yes	232000-007 Piping Angle CHKV Soldered
23 20 00	Piping, angle check valve, welded	Identity		Yes	232000-008 Piping Angle CHKV Welded
23 20 00	Piping, angle gate valve, flanged (elevation)	Identity		Yes	232000-009 Piping Angle GTV ELEV

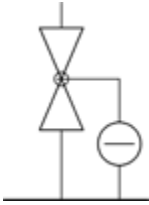
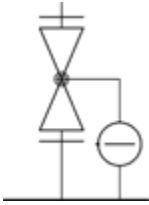

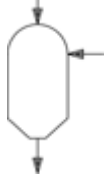

Division 23 –Heating, Ventilating, and Air Conditioning					
Master Format No.	Description	Type	Symbol	NCS Symbol	File Name (.dwg)
23 20 00	Piping, angle gate valve, flanged (plan)	Identity		Yes	232000-010 Piping Angle GTV Plan
23 20 00	Piping, angle gate valve, screwed (elevation)	Identity		Yes	232000-011 Piping Angle GTV ELEV
23 20 00	Piping, angle gate valve, screwed (plan)	Identity		Yes	232000-012 Piping Angle GTV Plan
23 20 00	Piping, angle gate valve, welded (elevation)	Identity		Yes	232000-013 Piping Angle GTV ELEV
23 20 00	Piping, angle gate valve, welded (plan)	Identity		Yes	232000-014 Piping Angle GTV Plan





Division 23 –Heating, Ventilating, and Air Conditioning					
Master Format No.	Description	Type	Symbol	NCS Symbol	File Name (.dwg)
23 20 00	Piping, angle globe valve (elevation)	Identity		Yes	232000-015 Piping Angle GLV ELEV
23 20 00	Piping, angle globe valve, flanged (elevation)	Identity		Yes	232000-016 Piping Angle GLV ELEV
23 20 00	Piping, angle globe valve, flanged (plan)	Identity		Yes	232000-017 Piping Angle GLV Plan
23 20 00	Piping, angle globe valve, screwed (elevation)	Identity		Yes	232000-018 Piping Angle GLV ELEV
23 20 00	Piping, angle globe valve, screwed (plan)	Identity		Yes	232000-019 Piping Angle GLV Plan
23 20 00	Piping, angle globe valve, soldered (plan)	Identity		Yes	232000-020 Piping Angle GLV Plan

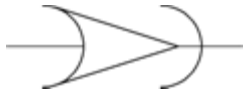

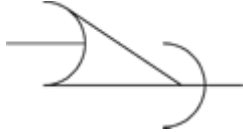
Division 23 –Heating, Ventilating, and Air Conditioning					
Master Format No.	Description	Type	Symbol	NCS Symbol	File Name (.dwg)
23 20 00	Piping, angle globe valve, welded (elevation)	Identity		Yes	232000-021 Piping Angle GLV ELEV
23 20 00	Piping, angle globe valve, welded (plan)	Identity		Yes	232000-022 Piping Angle GLV Plan
23 20 00	Piping, angle hose valve	Identity		Yes	232000-023 Piping Angle HV
23 20 00	Piping, automatic air vent	Identity		Yes	232000-024 Piping AAV
23 20 00	Piping, automatic bypass valve	Identity		Yes	232000-025 Piping AUTO Bypass Valve
23 20 00	Piping, automatic bypass valve, flanged	Identity		Yes	232000-026 Piping AUTO Bypass Valve

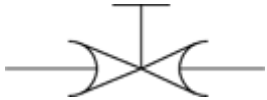

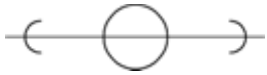

Division 23 –Heating, Ventilating, and Air Conditioning					
Master Format No.	Description	Type	Symbol	NCS Symbol	File Name (.dwg)
23 20 00	Piping, automatic expansion valve	Identity		Yes	232000-027 Piping AUTO EXP Valve
23 20 00	Piping, automatic governor operated valve, flanged	Identity		Yes	232000-028 Piping AUTO FLG Valve
23 20 00	Piping, automatic reducing valve	Identity		Yes	232000-029 Piping AUTO Reduce Valve
23 20 00	Piping, automatic reducing valve, flanged	Identity		Yes	232000-030 Piping AUTO Reduce Valve FLG
23 20 00	Piping, ball joint	Identity		Yes	232000-031 Piping Ball Joint

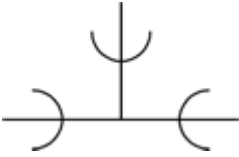

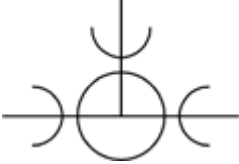
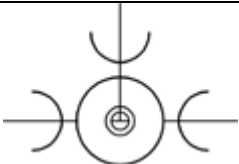

Division 23 –Heating, Ventilating, and Air Conditioning					
Master Format No.	Description	Type	Symbol	NCS Symbol	File Name (.dwg)
23 20 00	Piping, ball valve	Identity		Yes	232000-032 Piping Ball Valve
23 20 00	Piping, barometric condenser	Identity		Yes	232000-033 Piping Barometric COND
23 20 00	Piping, base elbow, screwed	Identity		Yes	232000-034 Piping Base Elbow Screwed
23 20 00	Piping, bell & spigot 45 degree elbow	Identity		Yes	232000-035 Piping B&S 45 DEG Elbow
23 20 00	Piping, bell & spigot 90 degree elbow	Identity		Yes	232000-036 Piping B&S 90 DEG Elbow

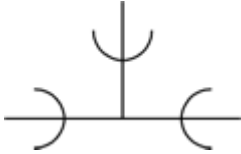



Division 23 –Heating, Ventilating, and Air Conditioning					
Master Format No.	Description	Type	Symbol	NCS Symbol	File Name (.dwg)
23 20 00	Piping, bell & spigot bull plug	Identity		Yes	232000-037 Piping B&S Bull Plug
23 20 00	Piping, bell & spigot cap	Identity		Yes	232000-038 Piping B&S Cap
23 20 00	Piping, bell & spigot concentric reducer	Identity		Yes	232000-039 Piping B&S CONC RDC
23 20 00	Piping, bell & spigot connecting pipe joint	Identity		Yes	232000-040 Piping B&S Connecting Joint
23 20 00	Piping, bell & spigot crossover	Identity		Yes	232000-041 Piping B&S Crossover
23 20 00	Piping, bell & spigot eccentric reducer	Identity		Yes	232000-042 Piping B&S ECC RDC





Division 23 –Heating, Ventilating, and Air Conditioning					
Master Format No.	Description	Type	Symbol	NCS Symbol	File Name (.dwg)
23 20 00	Piping, bell & spigot expansion bell joint	Identity		Yes	232000-043 Piping B&S EXP Bell Joint
23 20 00	Piping, bell & spigot gate valve (elevation)	Identity		Yes	232000-044 Piping B&S GTV ELEV
23 20 00	Piping, bell & spigot globe valve (elevation)	Identity		Yes	232000-045 Piping B&S GLV ELEV
23 20 00	Piping, bell & spigot outlet down tee	Identity		Yes	232000-046 Piping B&S OUT DWN Tee
23 20 00	Piping, bell & spigot outlet up tee	Identity		Yes	232000-047 Piping B&S Up Tee

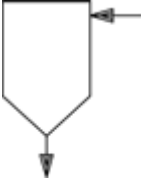
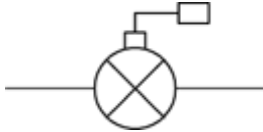

Division 23 –Heating, Ventilating, and Air Conditioning					
Master Format No.	Description	Type	Symbol	NCS Symbol	File Name (.dwg)
23 20 00	Piping, bell & spigot pipe plug	Identity		Yes	232000-048 Piping B&S Pipe Plug
23 20 00	Piping, bell & spigot reducing tee	Identity		Yes	232000-049 Piping B&S RDC Tee
23 20 00	Piping, bell & spigot safety valve	Identity		Yes	232000-050 Piping B&S Safety Valve
23 20 00	Piping, bell & spigot side outlet down tee	Identity		Yes	232000-051 Piping B&S Side OUT DWN Tee
23 20 00	Piping, bell & spigot side outlet tee	Identity		Yes	232000-052 Piping B&S Side OUT Tee

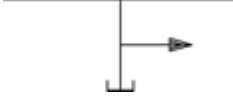

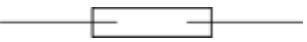
Division 23 –Heating, Ventilating, and Air Conditioning					
Master Format No.	Description	Type	Symbol	NCS Symbol	File Name (.dwg)
23 20 00	Piping, bell & spigot sleeve	Identity		Yes	232000-053 Piping B&S SLV
23 20 00	Piping, bell & spigot stop valve	Identity		Yes	232000-054 Piping B&S Stop Valve
23 20 00	Piping, bell & spigot straight size tee	Identity		Yes	232000-055 Piping B&S STR Tee
23 20 00	Piping, bell & spigot turned down elbow	Identity		Yes	232000-056 Piping B&S DWN Elbow
23 20 00	Piping, bell & spigot turned up elbow	Identity		Yes	232000-057 Piping B&S Up Elbow



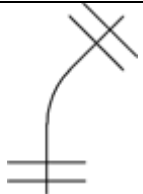
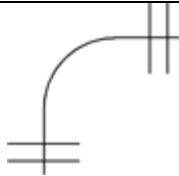
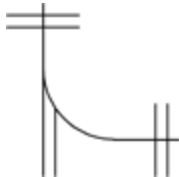

Division 23 –Heating, Ventilating, and Air Conditioning					
Master Format No.	Description	Type	Symbol	NCS Symbol	File Name (.dwg)
23 20 00	Piping, blind flange	Identity		Yes	232000-058 Piping Blind FLG
23 20 00	Piping, blow off strainer	Identity		Yes	232000-059 Piping Blow Off
23 20 00	Piping, boiler return trap	Identity		Yes	232000-060 Piping Boiler RET Tap
23 20 00	Piping, bushing bell & spigot	Identity		Yes	232000-061 Piping Bushing B&S
23 20 00	Piping, butterfly valve	Identity		Yes	232000-062 Piping BFV

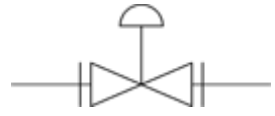
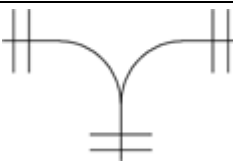

Division 23 –Heating, Ventilating, and Air Conditioning					
Master Format No.	Description	Type	Symbol	NCS Symbol	File Name (.dwg)
23 20 00	Piping, capillary tube	Identity		Yes	232000-063 Piping Capillary Tube
23 20 00	Piping, cock bell & spigot	Identity		Yes	232000-064 Piping Cock B&S
23 20 00	Piping, condenser jet	Identity		Yes	232000-065 Piping COND Jet
23 20 00	Piping, condenser water regulating valve	Identity		Yes	232000-066 Piping COND Water REG Valve
23 20 00	Piping, dielectric union	Identity		Yes	232000-067 Piping Dielectric Union



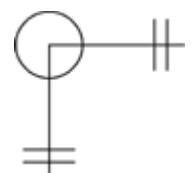
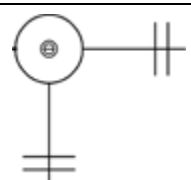

Division 23 –Heating, Ventilating, and Air Conditioning					
Master Format No.	Description	Type	Symbol	NCS Symbol	File Name (.dwg)
23 20 00	Piping, drain hose end	Identity		Yes	232000-068 Piping Drain Hose End
23 20 00	Piping, duplex strainer	Identity		Yes	232000-069 Piping Duplex Strainer
23 20 00	Piping, expansion hand valve	Identity		Yes	232000-070 Piping EXP Hand Valve
23 20 00	Piping, expansion joint	Identity		Yes	232000-071 Piping EJ
23 20 00	Piping, expansion loop	Identity		Yes	232000-072 Piping EXP loop

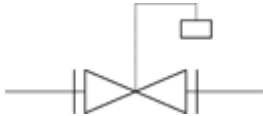
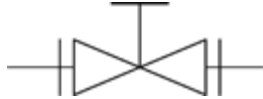
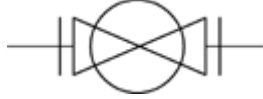



Division 23 –Heating, Ventilating, and Air Conditioning					
Master Format No.	Description	Type	Symbol	NCS Symbol	File Name (.dwg)
23 20 00	Piping, filter and strainer line	Identity		Yes	232000-073 Piping FLTR & STN Line
23 20 00	Piping, flanged 45 degree elbow	Identity		Yes	232000-074 Piping 45 DEG Elbow
23 20 00	Piping, flanged 90 degree elbow	Identity		Yes	232000-075 Piping 90 DEG Elbow
23 20 00	Piping, flanged base elbow	Identity		Yes	232000-076 Piping Base Elbow
23 20 00	Piping, flanged bull plug	Identity		Yes	232000-077 Piping Bull Plug

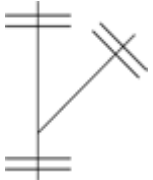

Division 23 –Heating, Ventilating, and Air Conditioning					
Master Format No.	Description	Type	Symbol	NCS Symbol	File Name (.dwg)
23 20 00	Piping, flanged cock	Identity		Yes	232000-078 Piping Flanged Cock
23 20 00	Piping, flanged concentric reducer	Identity		Yes	232000-079 Piping CONC RDCR
23 20 00	Piping, flanged connecting pipe joint	Identity		Yes	232000-080 Piping CONN Pipe Joint
23 20 00	Piping, flanged diaphragm valve	Identity		Yes	232000-081 Piping Diaphragm Valve
23 20 00	Piping, flanged double branch elbow	Identity		Yes	232000-082 Piping DBL Elbow

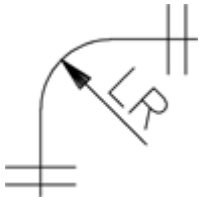

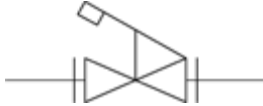

Division 23 –Heating, Ventilating, and Air Conditioning					
Master Format No.	Description	Type	Symbol	NCS Symbol	File Name (.dwg)
23 20 00	Piping, flanged double sweep tee	Identity		Yes	232000-083 Piping DBL Tee
23 20 00	Piping, flanged eccentric reducer	Identity		Yes	232000-084 Piping ECC RDCR
23 20 00	Piping, flanged elbow side outlet, down	Identity		Yes	232000-085 Piping Elbow Side OUT DWN
23 20 00	Piping, flanged elbow side outlet, up	Identity		Yes	232000-086 Piping Elbow Side OUT Up
23 20 00	Piping, flanged expansion joint	Identity		Yes	232000-087 Piping EJ

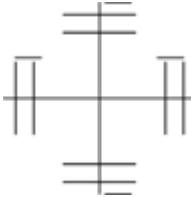

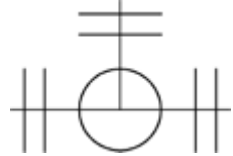
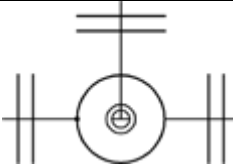

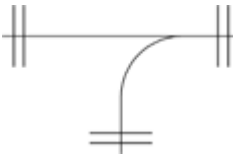
Division 23 –Heating, Ventilating, and Air Conditioning					
Master Format No.	Description	Type	Symbol	NCS Symbol	File Name (.dwg)
23 20 00	Piping, flanged float valve	Identity		Yes	232000-088 Piping Float Valve
23 20 00	Piping, flanged gate valve (elevation)	Identity		Yes	232000-089 Piping GTV ELEV
23 20 00	Piping, flanged gate valve (plan)	Identity		Yes	232000-090 Piping GTV Plan
23 20 00	Piping, flanged globe valve (elevation)	Identity		Yes	232000-091 Piping GLV ELEV
23 20 00	Piping, flanged globe valve (plan)	Identity		Yes	232000-092 Piping GLV Plan



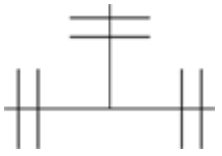

Division 23 –Heating, Ventilating, and Air Conditioning					
Master Format No.	Description	Type	Symbol	NCS Symbol	File Name (.dwg)
23 20 00	Piping, flanged hose angle valve	Identity		Yes	232000-093 Piping Hose L Valve
23 20 00	Piping, flanged hose gate valve	Identity		Yes	232000-094 Piping Hose GTV
23 20 00	Piping, flanged hose globe valve	Identity		Yes	232000-095 Piping Hose GLV
23 20 00	Piping, flanged lateral	Identity		Yes	232000-096 Piping Flanged LATL
23 20 00	Piping, flanged lock shield valve	Identity		Yes	232000-097 Piping Shield Valve



Division 23 –Heating, Ventilating, and Air Conditioning					
Master Format No.	Description	Type	Symbol	NCS Symbol	File Name (.dwg)
23 20 00	Piping, flanged long radius elbow	Identity		Yes	232000-098 Piping Long R Elbow
23 20 00	Piping, flanged orifice flange	Identity		Yes	232000-099 Piping Orifice Flange
23 20 00	Piping, flanged outlet down tee	Identity		Yes	232000-100 Piping OUT DWN Tee
23 20 00	Piping, flanged outlet up tee	Identity		Yes	232000-101 Piping OUT UP Tee
23 20 00	Piping, flanged quick opening valve	Identity		Yes	232000-102 Piping Opening Valve

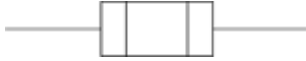

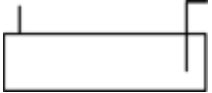
Division 23 –Heating, Ventilating, and Air Conditioning					
Master Format No.	Description	Type	Symbol	NCS Symbol	File Name (.dwg)
23 20 00	Piping, flanged reducing cross	Identity		Yes	232000-103 Pipinge RDCR Cross
23 20 00	Piping, flanged reducing flange	Identity		Yes	232000-104 Piping RDCR Flange
23 20 00	Piping, flanged safety valve	Identity		Yes	232000-105 Piping Safety Valve
23 20 00	Piping, flanged side outlet tee	Identity		Yes	232000-106 Piping Side OUT Tee
23 20 00	Piping, flanged side outlet up tee	Identity		Yes	232000-107 Piping Side OUT Up Tee

Division 23 –Heating, Ventilating, and Air Conditioning					
Master Format No.	Description	Type	Symbol	NCS Symbol	File Name (.dwg)
23 20 00	Piping, flanged single sweep tee	Identity		Yes	232000-108 Piping SGL Sweep Tee
23 20 00	Piping, flanged sleeve	Identity		Yes	232000-109 Piping FLG Sleeve
23 20 00	Piping, flanged spool piece	Identity		Yes	232000-110 Piping FLG Spool
23 20 00	Piping, flanged stop valve	Identity		Yes	232000-111 Piping FLG Stop Valve
23 20 00	Piping, flanged straight size tee	Identity		Yes	232000-112 Piping FLG STRT Tee

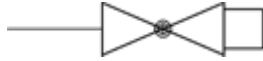
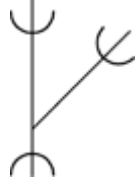
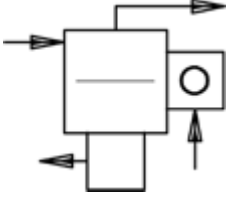

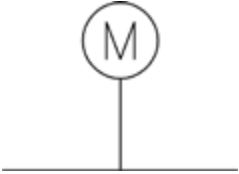
Division 23 –Heating, Ventilating, and Air Conditioning					
Master Format No.	Description	Type	Symbol	NCS Symbol	File Name (.dwg)
23 20 00	Piping, flanged turned down elbow	Identity		Yes	232000-113 Piping FLG DWN Elbow
23 20 00	Piping, flanged turned up elbow	Identity		Yes	232000-114 Piping FLG Up Elbow
23 20 00	Piping, flanged union	Identity		Yes	232000-115 Piping FLG Union
23 20 00	Piping, float and thermostatic trap	Identity		Yes	232000-116 Piping Thermostatic Trap
23 20 00	Piping, float trap	Identity		Yes	232000-117 Piping Float Trap

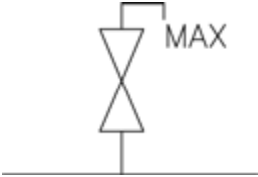

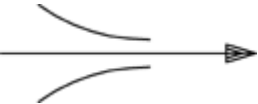
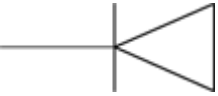
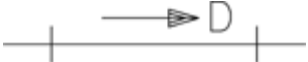

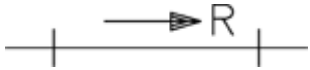
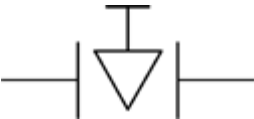
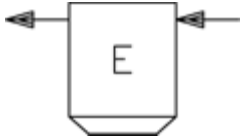
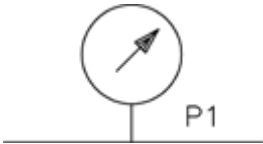
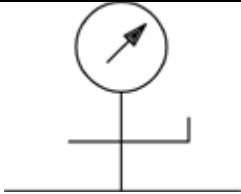
Division 23 –Heating, Ventilating, and Air Conditioning					
Master Format No.	Description	Type	Symbol	NCS Symbol	File Name (.dwg)
23 20 00	Piping, heat, liquid exchanger	Identity		Yes	232000-118 Piping Heat Liquid EXCH
23 20 00	Piping, heat, transfer surface	Identity		Yes	232000-119 Piping Heat XFER SURF
23 20 00	Piping, high pressure horizontal receiver	Identity		Yes	232000-120 Piping PRESS RCVR HORIZ
23 20 00	Piping, high pressure vertical receiver	Identity		Yes	232000-121 Piping PRESS VERT RCVR
23 20 00	Piping, high side float valve	Identity		Yes	232000-122 Piping High Side Float Valve

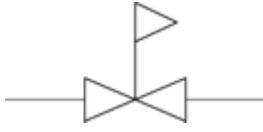
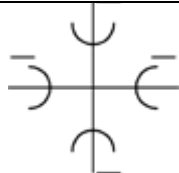
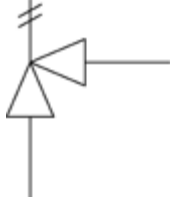

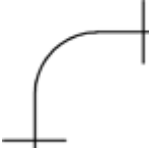
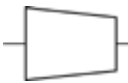

Division 23 –Heating, Ventilating, and Air Conditioning					
Master Format No.	Description	Type	Symbol	NCS Symbol	File Name (.dwg)
23 20 00	Piping, hose globe valve	Identity		Yes	232000-123 Piping Hose GLV
23 20 00	Piping, lateral bell & spigot	Identity		Yes	232000-124 Piping Lateral B&S
23 20 00	Piping, low pressure receiver	Identity		Yes	232000-125 Piping Low PRESS RCVR
23 20 00	Piping, low side float valve	Identity		Yes	232000-126 Piping Low Side Float Valve
23 20 00	Piping, magnetic stop valve	Identity		Yes	232000-127 Piping MAG Stop Valve

Division 23 –Heating, Ventilating, and Air Conditioning					
Master Format No.	Description	Type	Symbol	NCS Symbol	File Name (.dwg)
23 20 00	Piping, manual air vent	Identity		Yes	232000-128 Piping MAV
23 20 00	Piping, needle valve	Identity		Yes	232000-129 Piping Needle Valve
23 20 00	Piping, nozzle flow	Identity		Yes	232000-130 Piping Nozzle Flow
23 20 00	Piping, pipe plug	Identity		Yes	232000-131 Piping Plug
23 20 00	Piping, pitch or pipe drop	Identity		Yes	232000-132 Piping Pitch Drop



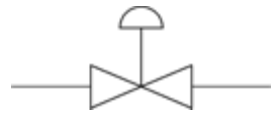

Division 23 –Heating, Ventilating, and Air Conditioning					
Master Format No.	Description	Type	Symbol	NCS Symbol	File Name (.dwg)
23 20 00	Piping, pitch or pipe rise	Identity		Yes	232000-133 Piping Pitch Rise
23 20 00	Piping, plug valve	Identity		Yes	232000-134 Piping Plug Valve
23 20 00	Piping, precipitator	Identity		Yes	232000-135 Piping Precipitator
23 20 00	Piping, pressure gauge	Identity		Yes	232000-136 Piping PRESS Gauge
23 20 00	Piping, pressure gage and cock	Identity		Yes	232000-137 Piping PRESS Gauge & Cock

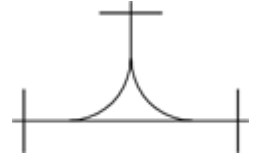

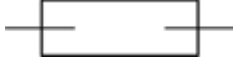
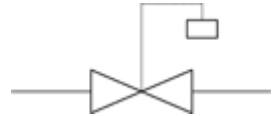
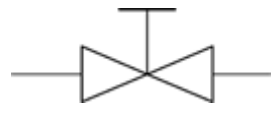
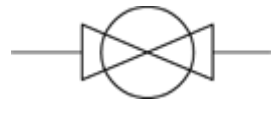
Division 23 –Heating, Ventilating, and Air Conditioning					
Master Format No.	Description	Type	Symbol	NCS Symbol	File Name (.dwg)
23 20 00	Piping, pressure reducing valve	Identity		Yes	232000-138 Piping PRESS RDCR Valve
23 20 00	Piping, reducing bell & spigot cross	Identity		Yes	232000-139 Piping RDRC B&S Cross
23 20 00	Piping, relief or safety valve	Identity		Yes	232000-140 Piping Relief
23 20 00	Piping, rupture disc	Identity		Yes	232000-141 Piping Rupture Disc
23 20 00	Piping, screwed 45 degree elbow	Identity		Yes	232000-142 Piping Screwed 45 DEG Elbow



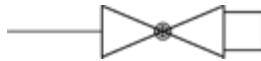

Division 23 –Heating, Ventilating, and Air Conditioning					
Master Format No.	Description	Type	Symbol	NCS Symbol	File Name (.dwg)
23 20 00	Piping, screwed 90 degree elbow	Identity		Yes	232000-143 Piping Screwed 90 DEG Elbow
23 20 00	Piping, screwed bushing	Identity		Yes	232000-144 Piping Screwed Bushing
23 20 00	Piping, screwed cap	Identity		Yes	232000-145 Piping Screwed Cap
23 20 00	Piping, screwed cock	Identity		Yes	232000-146 Piping Screwed Cock
23 20 00	Piping, screwed concentric reducer	Identity		Yes	232000-147 Piping Screwed CONC RDCR

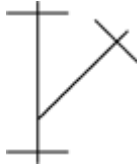
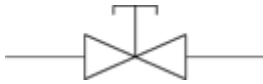
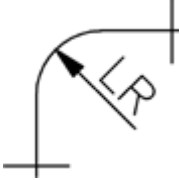

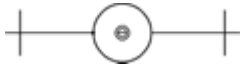
Division 23 –Heating, Ventilating, and Air Conditioning					
Master Format No.	Description	Type	Symbol	NCS Symbol	File Name (.dwg)
23 20 00	Piping, screwed connecting pipe joint	Identity		Yes	232000-148 Piping Screwed Pipe Joint
23 20 00	Piping, screwed crossover	Identity		Yes	232000-149 Piping Screwed Crossover
23 20 00	Piping, screwed diaphragm valve	Identity		Yes	232000-150 Piping Screwed Diaphragm valve
23 20 00	Piping, screwed double branch elbow	Identity		Yes	232000-151 Piping DBL Branch Elbow
23 20 00	Piping, screwed double sweep tee	Identity		Yes	232000-152 Piping Screwed DBL Sweep Tee

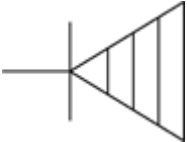

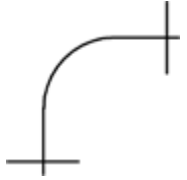
Division 23 –Heating, Ventilating, and Air Conditioning					
Master Format No.	Description	Type	Symbol	NCS Symbol	File Name (.dwg)
23 20 00	Piping, screwed eccentric reducer	Identity		Yes	232000-153 Piping Screwed ECC RDCR
23 20 00	Piping, screwed expansion joint	Identity		Yes	232000-154 Piping Screwed EJ
23 20 00	Piping, screwed float valve	Identity		Yes	232000-155 Piping Screwed Float Valve
23 20 00	Piping, screwed gate valve (elevation)	Identity		Yes	232000-156 Piping Screwed GTV ELEV
23 20 00	Piping, screwed gate valve (plan)	Identity		Yes	232000-157 Piping Screwed GTV Plan

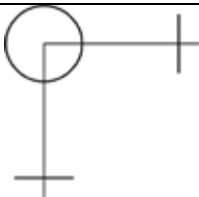

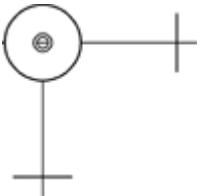
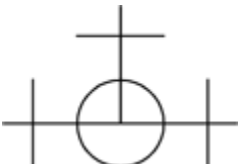
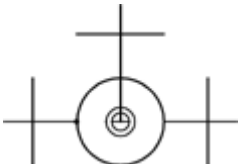
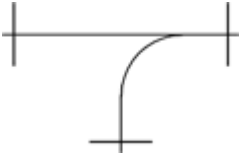
Division 23 –Heating, Ventilating, and Air Conditioning					
Master Format No.	Description	Type	Symbol	NCS Symbol	File Name (.dwg)
23 20 00	Piping, screwed globe valve (elevation)	Identity		Yes	232000-158 Piping Screwed GLV ELEV
23 20 00	Piping, screwed globe valve (plan)	Identity		Yes	232000-159 Piping Screwed GLV Plan
23 20 00	Piping, screwed hose angle valve	Identity		Yes	232000-160 Piping Screwed Hose L Valve
23 20 00	Piping, screwed hose gate valve	Identity		Yes	232000-161 Piping Screwed Hose GTV
23 20 00	Piping, screwed hose globe valve	Identity		Yes	232000-162 Piping Screwed Hose GLV

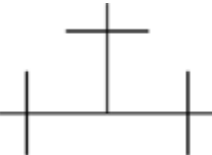
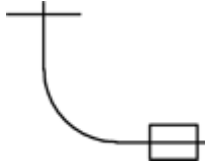
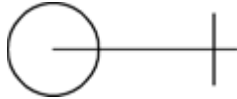

Division 23 –Heating, Ventilating, and Air Conditioning					
Master Format No.	Description	Type	Symbol	NCS Symbol	File Name (.dwg)
23 20 00	Piping, screwed lateral	Identity		Yes	232000-163 Piping Screwed Lateral
23 20 00	Piping, screwed lock shield valve	Identity		Yes	232000-164 Piping Lock Shield Valve
23 20 00	Piping, screwed long radius elbow	Identity		Yes	232000-165 Piping Screwed Long R Elbow
23 20 00	Piping, screwed outlet down tee	Identity		Yes	232000-166 Piping Screwed OUT DWN Tee
23 20 00	Piping, screwed outlet up tee	Identity		Yes	232000-167 Piping Screwed OUT Up Tee



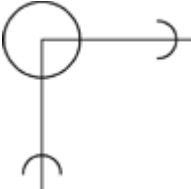
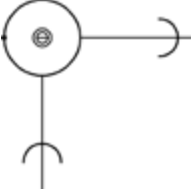

Division 23 –Heating, Ventilating, and Air Conditioning					
Master Format No.	Description	Type	Symbol	NCS Symbol	File Name (.dwg)
23 20 00	Piping, screwed pipe plug	Identity		Yes	232000-168 Piping Screwed Plug
23 20 00	Piping, screwed quick opening valve	Identity		Yes	232000-169 Piping Screwed Opening Valve
23 20 00	Piping, screwed reducing elbow	Identity		Yes	232000-170 Piping Screwed RDCR Elbow
23 20 00	Piping, screwed safety valve	Identity		Yes	232000-171 Piping Screwed Safety Valve
23 20 00	Piping, screwed side outlet elbow, down	Identity		Yes	232000-172 Piping Screwed Side OUT Elbow DWN

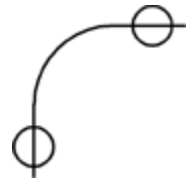

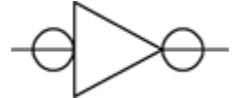

Division 23 –Heating, Ventilating, and Air Conditioning					
Master Format No.	Description	Type	Symbol	NCS Symbol	File Name (.dwg)
23 20 00	Piping, screwed side outlet elbow, up	Identity		Yes	232000-173 Piping Screwed Side OUT Elbow UP
23 20 00	Piping, screwed side outlet tee	Identity		Yes	232000-174 Piping Screwed Side OUT Tee
23 20 00	Piping, screwed side outlet up tee	Identity		Yes	232000-175 Piping Screwed Side OUT UP Tee
23 20 00	Piping, screwed single sweep tee	Identity		Yes	232000-176 Piping Screwed SGL Sweep Tee
23 20 00	Piping, screwed sleeve	Identity		Yes	232000-177 Piping Screwed Sleeve

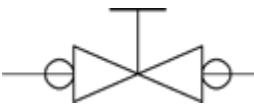



Division 23 –Heating, Ventilating, and Air Conditioning					
Master Format No.	Description	Type	Symbol	NCS Symbol	File Name (.dwg)
23 20 00	Piping, screwed stop valve	Identity		Yes	232000-178 Piping Screwed Stop Valve
23 20 00	Piping, screwed straight size tee	Identity		Yes	232000-179 Piping Screwed STR Tee
23 20 00	Piping, screwed street elbow	Identity		Yes	232000-180 Piping Screwed ST Elbow
23 20 00	Piping, screwed turned down elbow	Identity		Yes	232000-181 Piping Screwed DWN Elbow
23 20 00	Piping, screwed turned up elbow	Identity		Yes	232000-182 Piping Screwed Up Elbow

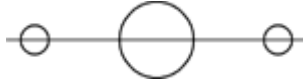

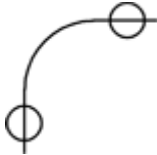

Division 23 –Heating, Ventilating, and Air Conditioning					
Master Format No.	Description	Type	Symbol	NCS Symbol	File Name (.dwg)
23 20 00	Piping, screwed union	Identity		Yes	232000-183 Piping Screwed Union
23 20 00	Piping, side outlet elbow, bell & spigot, outlet down	Identity		Yes	232000-184 Piping Side OUT Elbow B&S DWN
23 20 00	Piping, side outlet elbow, bell & spigot, outlet up	Identity		Yes	232000-185 Piping Side OUT Elbow B&S OUT Up
23 20 00	Piping, sight glass	Identity		Yes	232000-186 Piping Sight Glass
23 20 00	Piping, sleeve	Identity		Yes	232000-187 Piping Sleeve

Division 23 –Heating, Ventilating, and Air Conditioning					
Master Format No.	Description	Type	Symbol	NCS Symbol	File Name (.dwg)
23 20 00	Piping, soldered 45 degree elbow	Identity		Yes	232000-188 Piping Soldered 45 DEG Elbow
23 20 00	Piping, soldered 90 degree elbow	Identity		Yes	232000-189 Piping Soldered 90 DEG Elbow
23 20 00	Piping, soldered bushing	Identity		Yes	232000-190 Piping Soldered Bushing
23 20 00	Piping, soldered cock	Identity		Yes	232000-191 Piping Soldered Rock
23 20 00	Piping, soldered concentric reducer	Identity		Yes	232000-192 Piping Soldered CONC RDCR

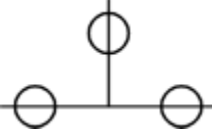



Division 23 –Heating, Ventilating, and Air Conditioning					
Master Format No.	Description	Type	Symbol	NCS Symbol	File Name (.dwg)
23 20 00	Piping, soldered connecting pipe joint	Identity		Yes	232000-193 Piping Soldered Pipe Joint
23 20 00	Piping, soldered eccentric reducer	Identity		Yes	232000-194 Piping Soldered ECC RDCR
23 20 00	Piping, soldered expansion joint	Identity		Yes	232000-195 Piping Soldered EJ
23 20 00	Piping, soldered gate valve	Identity		Yes	232000-196 Piping Soldered GTV
23 20 00	Piping, soldered globe valve (elevation)	Identity		Yes	232000-197 Piping Soldered GLV ELEV



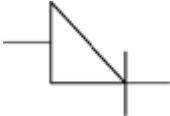
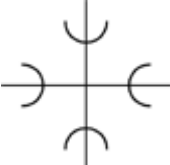
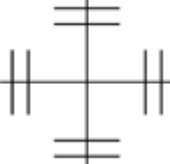
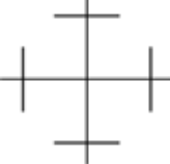
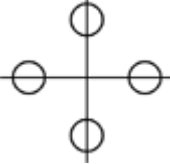

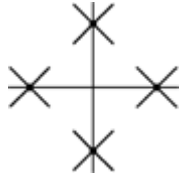
Division 23 –Heating, Ventilating, and Air Conditioning					
Master Format No.	Description	Type	Symbol	NCS Symbol	File Name (.dwg)
23 20 00	Piping, soldered globe valve (plan)	Identity		Yes	232000-198 Piping Soldered GLV Plan
23 20 00	Piping, soldered lock shield valve	Identity		Yes	232000-199 Piping Soldered Lock Shield Valve
23 20 00	Piping, soldered outlet down tee	Identity		Yes	232000-200 Piping Soldered OUT DWN Tee
23 20 00	Piping, soldered outlet up tee	Identity		Yes	232000-201 Piping Soldered OUT Up Tee
23 20 00	Piping, soldered quick opening valve	Identity		Yes	232000-202 Piping Soldered Quick Open Valve





Division 23 –Heating, Ventilating, and Air Conditioning					
Master Format No.	Description	Type	Symbol	NCS Symbol	File Name (.dwg)
23 20 00	Piping, soldered reducing elbow	Identity		Yes	232000-203 Piping Soldered RDCR Elbow
23 20 00	Piping, soldered safety valve	Identity		Yes	232000-204 Piping Soldered SV
23 20 00	Piping, soldered sleeve	Identity		Yes	232000-205 Piping Soldered Sleeve
23 20 00	Piping, soldered stop valve	Identity		Yes	232000-206 Piping Soldered Stop Valve
23 20 00	Piping, soldered straight size tee	Identity		Yes	232000-207 Piping Soldered Straight Tee

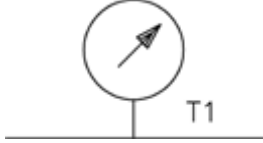

Division 23 –Heating, Ventilating, and Air Conditioning					
Master Format No.	Description	Type	Symbol	NCS Symbol	File Name (.dwg)
23 20 00	Piping, soldered turned down elbow	Identity		Yes	232000-208 Piping Soldered DWN Elbow
23 20 00	Piping, soldered turned up elbow	Identity		Yes	232000-209 Piping Soldered Up Elbow
23 20 00	Piping, soldered union	Identity		Yes	232000-210 Piping Soldered Union
23 20 00	Piping, square head cock	Identity		Yes	232000-211 Piping Square Head Cock
23 20 00	Piping, steam trap (indicate type)	Identity		Yes	232000-212 Piping Steam Trap

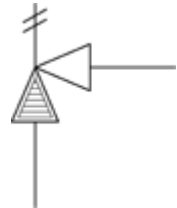

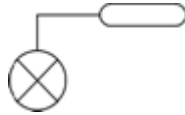
Division 23 –Heating, Ventilating, and Air Conditioning					
Master Format No.	Description	Type	Symbol	NCS Symbol	File Name (.dwg)
23 20 00	Piping, straight crown eccentric reducer	Identity		Yes	232000-213 Piping STR CRN ECC RDRC
23 20 00	Piping, straight size bell & spigot cross	Identity		Yes	232000-214 Piping STR B&S Cross
23 20 00	Piping, straight size flanged cross	Identity		Yes	232000-215 Piping STR FLG Cross
23 20 00	Piping, straight size screwed cross	Identity		Yes	232000-216 Piping STR Screwed Cross
23 20 00	Piping, straight size soldered cross	Identity		Yes	232000-217 Piping Straight Soldered Cross

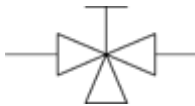

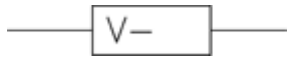
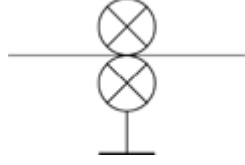
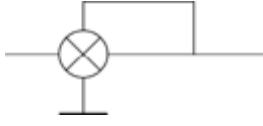

Division 23 –Heating, Ventilating, and Air Conditioning					
Master Format No.	Description	Type	Symbol	NCS Symbol	File Name (.dwg)
23 20 00	Piping, straight size welded cross	Identity		Yes	232000-218 Piping STR Welded Cross
23 20 00	Piping, straight way bell & spigot check valve	Identity		Yes	232000-219 Piping STR B&S CHKV
23 20 00	Piping, straight way flanged check valve	Identity		Yes	232000-220 Piping STR FLG CHKV
23 20 00	Piping, straight way screwed check valve	Identity		Yes	232000-221 Piping STR CHKV
23 20 00	Piping, straight way soldered check valve	Identity		Yes	232000-222 Piping STR Soldered CHKV

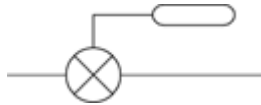

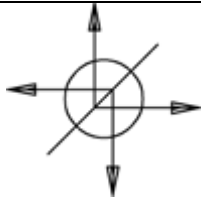
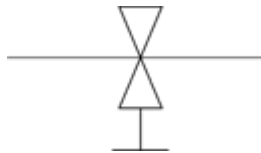
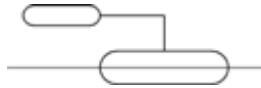

Division 23 –Heating, Ventilating, and Air Conditioning					
Master Format No.	Description	Type	Symbol	NCS Symbol	File Name (.dwg)
23 20 00	Piping, straight way welded check valve	Identity		Yes	232000-223 Piping STR Welded CHKV
23 20 00	Piping, strainer	Identity		Yes	232000-224 Piping Strainer
23 20 00	Piping, strainer (plan)	Identity		Yes	232000-225 Piping Strainer Plan
23 20 00	Piping, swing gate check valve	Identity		Yes	232000-226 Piping Swing Gate CHKV
23 20 00	Piping, temperature gauge	Identity		Yes	232000-227 Piping Temp Gauge



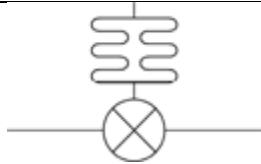
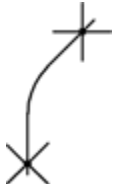

Division 23 –Heating, Ventilating, and Air Conditioning					
Master Format No.	Description	Type	Symbol	NCS Symbol	File Name (.dwg)
23 20 00	Piping, temperature pressure relief valve	Identity		Yes	232000-228 Piping Temp PRESS Relief Valve
23 20 00	Piping, thermostatic blast trap	Identity		Yes	232000-229 Piping THERMO Blast Trap
23 20 00	Piping, thermostatic expansion valve	Identity		Yes	232000-230 Piping THERMO EXP Valve
23 20 00	Piping, thermostatic trap	Identity		Yes	232000-231 Piping THERMO Trap
23 20 00	Piping, three-way manual valve	Identity		Yes	232000-232 Piping Three Way MAN Valve

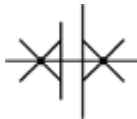

Division 23 –Heating, Ventilating, and Air Conditioning					
Master Format No.	Description	Type	Symbol	NCS Symbol	File Name (.dwg)
23 20 00	Piping, trap scale	Identity		Yes	232000-233 Piping Trap Scale
23 20 00	Piping, turned down 45 degree elbow	Identity		Yes	232000-234 Piping DWN 45 DEG Elbow
23 20 00	Piping, unclassified valve	Identity		Yes	232000-235 Piping Unclassified Valve
23 20 00	Piping, valve, constant pressure suction	Identity		Yes	232000-236 Piping Valve PRESS Suction
23 20 00	Piping, valve, evaporative pressure, regular snap action	Identity		Yes	232000-237 Piping Valve PRESS EVAP Snap



Division 23 –Heating, Ventilating, and Air Conditioning					
Master Format No.	Description	Type	Symbol	NCS Symbol	File Name (.dwg)
23 20 00	Piping, valve, evaporative pressure, regular throttling	Identity		Yes	232000-238 Piping Valve PRESS EVAP REG
23 20 00	Piping, valve, evaporative pressure, regular throttling evaporator	Identity		Yes	232000-239 Piping Valve EVAP PRESS Throttling
23 20 00	Piping, valve, refrigerant reversing	Identity		Yes	232000-240 Piping Valve Reversing
23 20 00	Piping, valve, snap action	Identity		Yes	232000-241 Piping Valve Snap
23 20 00	Piping, valve, thermosuction	Identity		Yes	232000-242 Piping Valve Thermosuction

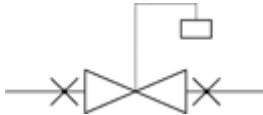

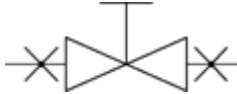
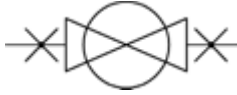

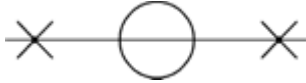
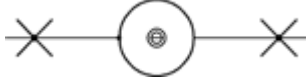
Division 23 –Heating, Ventilating, and Air Conditioning					
Master Format No.	Description	Type	Symbol	NCS Symbol	File Name (.dwg)
23 20 00	Piping, valve actuator manual gear	Identity		Yes	232000-243 Piping Valve Actuator MAN Gear
23 20 00	Piping, valve actuator manual lever	Identity		Yes	232000-244 Piping Valve Actuator MAN Lever
23 20 00	Piping, valve actuator manual non-rise stem	Identity		Yes	232000-245 Piping Valve Actuator Non Rise Stem
23 20 00	Piping, valve actuator manual out stem/yoke	Identity		Yes	232000-246 Piping Valve Actuator MAN Out Stem
23 20 00	Piping, valve compressor suction pressure	Identity		Yes	232000-247 Piping Valve Compressor PRESS

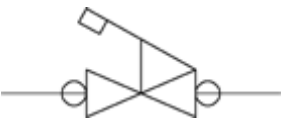
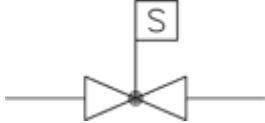
Division 23 –Heating, Ventilating, and Air Conditioning					
Master Format No.	Description	Type	Symbol	NCS Symbol	File Name (.dwg)
23 20 00	Piping, water valve	Identity		Yes	232000-248 Piping Water Valve
23 20 00	Piping, welded 45 degree elbow	Identity		Yes	232000-249 Piping Welded 45 DEG Elbow
23 20 00	Piping, welded 90 degree elbow	Identity		Yes	232000-250 Piping Welded 90 DEGG Elbow
23 20 00	Piping, welded bushing	Identity		Yes	232000-251 Piping Welded Bushing
23 20 00	Piping, welded cock	Identity		Yes	232000-252 Piping Welded Cock

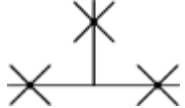
Division 23 –Heating, Ventilating, and Air Conditioning					
Master Format No.	Description	Type	Symbol	NCS Symbol	File Name (.dwg)
23 20 00	Piping, welded concentric reducer	Identity		Yes	232000-253 Piping Welded CONC REDCR
23 20 00	Piping, welded connecting pipe joint	Identity		Yes	232000-254 Pipe Welded CONC Pipe Joint
23 20 00	Piping, welded eccentric reducer	Identity		Yes	232000-255 Piping Welded ECC RDCR
23 20 00	Piping, welded expansion joint	Identity		Yes	232000-256 Piping Welded EXP Joint
23 20 00	Piping, welded float valve	Identity		Yes	232000-257 Piping Welded Float Valve

Division 23 –Heating, Ventilating, and Air Conditioning					
Master Format No.	Description	Type	Symbol	NCS Symbol	File Name (.dwg)
23 20 00	Piping, welded gate valve (elevation)	Identity		Yes	232000-258 Piping Welded GTV ELEV
23 20 00	Piping, welded gate valve (plan)	Identity		Yes	232000-259 Piping Welded GTV Plan
23 20 00	Piping, welded globe valve	Identity		Yes	232000-260 Piping Welded GLV
23 20 00	Piping, welded outlet down tee	Identity		Yes	232000-261 Piping Welded OUT DWN Tee
23 20 00	Piping, welded outlet up tee	Identity		Yes	232000-262 Piping Welded OUT Up TEE

Division 23 –Heating, Ventilating, and Air Conditioning					
Master Format No.	Description	Type	Symbol	NCS Symbol	File Name (.dwg)
23 20 00	Piping, welded quick opening valve	Identity		Yes	232000-263 Piping Welded Quick Open Valve
23 20 00	Piping, welded safety valve	Identity		Yes	232000-264 Piping Welded Safety Valve
23 20 00	Piping, welded sleeve	Identity		Yes	232000-265 Piping Welded Sleeve
23 20 00	Piping, welded stop valve	Identity		Yes	232000-266 Piping Welded Stop Valve
23 20 00	Piping, welded straight size tee	Identity		Yes	232000-267 Piping Welded Straight Tee

Division 23 –Heating, Ventilating, and Air Conditioning					
Master Format No.	Description	Type	Symbol	NCS Symbol	File Name (.dwg)
23 20 00	Piping, welded turned down elbow	Identity		Yes	232000-268 Piping Welded turned Down Elbow
23 20 00	Piping, welded turned up elbow	Identity		Yes	232000-269 Piping Welded turned Up Elbow
23 20 00	Piping, welded union	Identity		Yes	232000-270 Piping Welded Union
23 20 00	Air relief line = ATV; thin line, 2.5 mm (3/32") text	Line		Yes	N/A
23 20 00	Boiler blow down line = BBD; thin line, 2.5 mm (3/32") text	Line		Yes	N/A





Division 23 –Heating, Ventilating, and Air Conditioning					
Master Format No.	Description	Type	Symbol	NCS Symbol	File Name (.dwg)
23 20 00	Condensate line = C; thin line, 2.5 mm (3/32") text	Line	——— C ———	Yes	N/A
23 20 00	Drain line, condensate (below floor) = ST; thin line, 5 mm (3/16") dash, 3 mm space, 2.5 mm (3/32") text	Line	——— ST ———	Yes	N/A
23 20 00	Humidification line = H; thin line, 2.5 mm (3/32") text	Line	——— H ———	Yes	N/A
23 20 00	Pumped condensate line = PC; thin line, 2.5 mm (3/32") text	Line	——— PC ———	Yes	N/A
23 20 00	Return line, brine = BR; thin line, 2.5 mm (3/32") text	Line	——— BR ———	Yes	N/A



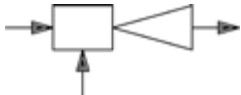

Division 23 –Heating, Ventilating, and Air Conditioning					
Master Format No.	Description	Type	Symbol	NCS Symbol	File Name (.dwg)
23 20 00	Return line, condenser water = CR; thin line, 2.5 mm (3/32") text	Line	———— CR ————	Yes	N/A
23 20 00	Return line, dual temperature = DTR; thin line, 2.5 mm (3/32") text	Line	———— DTR ————	Yes	N/A
23 20 00	Return line, glycol heating = GHR; thin line, 2.5 mm (3/32") text	Line	———— GHR ————	Yes	N/A
23 20 00	Return line, high pressure condensate = HPC; thin line, 2.5 mm (3/32") text	Line	———— HPC ————	Yes	N/A
23 20 00	Return line, high temperature hot water = HTWR; thin line, 2.5 mm (3/32") text	Line	———— HTWR ————	Yes	N/A





Division 23 –Heating, Ventilating, and Air Conditioning					
Master Format No.	Description	Type	Symbol	NCS Symbol	File Name (.dwg)
23 20 00	Return line, low pressure condensate = LPC; thin line, 2.5 mm (3/32") text	Line	——— LPC ———	Yes	N/A
23 20 00	Return line, low temperature hot water = HWR; thin line, 2.5 mm (3/32") text	Line	——— HWR ———	Yes	N/A
23 20 00	Return line, medium pressure condensate = MPC; thin line, 2.5 mm (3/32") text	Line	——— MPC ———	Yes	N/A
23 20 00	Return line, medium temperature hot water = MTWR; thin line, 2.5 mm (3/32") text	Line	——— MTWR ———	Yes	N/A
23 20 00	Steam line, low pressure = LPS; thin line, 2.5 mm (3/32") text	Line	——— LPS ———	Yes	N/A

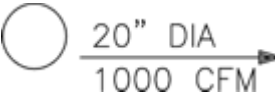

Division 23 –Heating, Ventilating, and Air Conditioning					
Master Format No.	Description	Type	Symbol	NCS Symbol	File Name (.dwg)
23 20 00	Steam line, medium pressure = MPS; thin line, 2.5 mm (3/32") text	Line	——— MPS ———	Yes	N/A
23 20 00	Supply line, brine = B; thin line, 2.5 mm (3/32") text	Line	——— B ——	Yes	N/A
23 20 00	Supply line, dual temperature = DTS; thin line, 2.5 mm (3/32") text	Line	——— DTS ——	Yes	N/A
23 20 00	Supply line, glycol heating = GHS; thin line, 2.5 mm (3/32") text	Line	——— GHS ——	Yes	N/A
23 20 00	Supply line, high pressure steam = HPS; thin line, 2.5 mm (3/32") text	Line	——— HPS ——	Yes	N/A

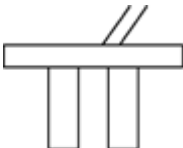



Division 23 –Heating, Ventilating, and Air Conditioning					
Master Format No.	Description	Type	Symbol	NCS Symbol	File Name (.dwg)
23 20 00	Supply line, low temperature hot water = HWS; thin line, 2.5 mm (3/32") text	Line	———— HWS ————	Yes	N/A
23 20 00	Supply line, medium temperature hot water = MTWS; thin line, 2.5 mm (3/32") text	Line	———— MTWS ————	Yes	N/A
23 20 00	Water line, condenser flow = C; thin line, 2.5 mm (3/32") text	Line	———— C ————	Yes	N/A
23 20 00	Water line, hot; thin line, 5 mm (3/16") dash, 2 mm (5/64") space	Line	—— — — — —	Yes	N/A
23 20 00	Water line, make up = MU; thin line, 2.5 mm (3/32") text	Line	———— MU ————	Yes	N/A



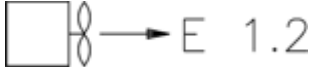
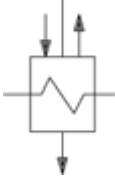

Division 23 –Heating, Ventilating, and Air Conditioning					
Master Format No.	Description	Type	Symbol	NCS Symbol	File Name (.dwg)
23 21 00	Piping, condensing steam turbine	Identity		Yes	232100-01 Piping Condensing Turbine
23 21 00	Piping, dynamic pump	Identity		Yes	232100-02 Piping Dynamic Pump
23 21 00	Piping, pump (plan) (indicate use)	Identity		Yes	232100-03 Piping Pump Plan
23 21 00	Piping, pump (schematic) (indicate use)	Identity		Yes	232100-04 Piping Pump SCHEM
23 21 00	Piping, steam turbine	Identity		Yes	232100-05 Piping Steam Turbine





Division 23 –Heating, Ventilating, and Air Conditioning					
Master Format No.	Description	Type	Symbol	NCS Symbol	File Name (.dwg)
23 23 00	Refrigerant discharge line = RD; thin line, 2.5 mm (3/32") text	Line		Yes	N/A
23 23 00	Refrigerant liquid line = RL; thin line, 2.5 mm (3/32") text	Line		Yes	N/A
23 23 00	Refrigerant suction line = RS; thin line, 2.5 mm (3/32") text	Line		Yes	N/A
23 30 00	Air distribution, ceiling spout outlet	Line		Yes	233000-001 Ceiling Spout
23 30 00	Air distribution, supply outlet, wall	Identity		Yes	233000-002 Supply OUT Wall

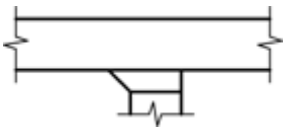

Division 23 –Heating, Ventilating, and Air Conditioning					
Master Format No.	Description	Type	Symbol	NCS Symbol	File Name (.dwg)
23 30 00	Damper, manual volume	Identity		Yes	233000-003 DMPR Manual Volume
23 30 00	Damper heater, duct, electric	Identity		Yes	233000-004 DMPR Heater
23 30 00	Duct section, change in static pressure rating tag	Identity		Yes	233000-005 Change in ST PR Rating
23 30 00	Duct section, static pressure rating tag	Identity		Yes	233000-006 ST PR Rating
23 30 00	Fan, blower	Identity		Yes	233000-007 Fan Blower





Division 23 –Heating, Ventilating, and Air Conditioning					
Master Format No.	Description	Type	Symbol	NCS Symbol	File Name (.dwg)
23 30 00	Fan, exhaust roof vent	Identity		Yes	233000-008 Fan Exhaust Roof Vent
23 30 00	Fan, intake roof vent	Identity		Yes	233000-009 Intake Roof Vent
23 30 00	Fan, louvered roof vent	Identity		Yes	233000-010 LRV
23 30 00	Fan, propeller	Identity		Yes	233000-011 Propeller
23 30 00	Heater, feed with air outlet	Identity		Yes	233000-012 Heater

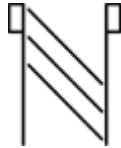
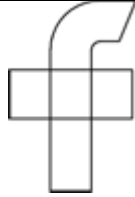

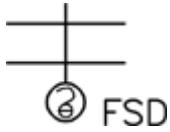
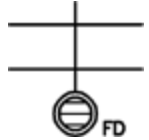

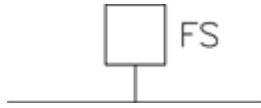
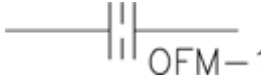
Division 23 –Heating, Ventilating, and Air Conditioning					
Master Format No.	Description	Type	Symbol	NCS Symbol	File Name (.dwg)
23 31 00	Access door (AD) or access panel (AP)	Identity		Yes	233100-001 Access Door
23 31 00	Air distribution, flexible connector	Identity		Yes	233100-002 Flexible Connector
23 31 00	Air distribution, transition	Identity		Yes	233100-003 Transition
23 31 00	Duct, flexible	Identity		Yes	233100-004 Duct Flexible
23 31 00	Duct section, exhaust air down	Identity		Yes	233100-005 EXH Air DWN



Division 23 –Heating, Ventilating, and Air Conditioning					
Master Format No.	Description	Type	Symbol	NCS Symbol	File Name (.dwg)
23 31 00	Duct section, exhaust air up	Identity		Yes	233100-006 EXH Air Up
23 31 00	Duct section, return air	Identity		Yes	233100-007 RA
23 31 00	Duct section, return air down	Identity		Yes	233100-008 RA DWN
23 31 00	Duct section, standard branch for supply and return	Identity		Yes	233100-009 STD Supply & Return
23 31 00	Duct section, supply air	Identity		Yes	233100-010 Supply Air

Division 23 –Heating, Ventilating, and Air Conditioning					
Master Format No.	Description	Type	Symbol	NCS Symbol	File Name (.dwg)
23 31 00	Duct section, supply air down	Identity		Yes	233100-011 Supply Air DWN
23 31 00	Duct section, wye junction	Identity		Yes	233100-012 WYE Junction
23 31 00	Ductwork, change in elevation	Identity		Yes	233100-013 Change In ELEV
23 33 00	Air distribution, adjustable blank off damper	Identity		Yes	233300-001 Adjustable Blank off DMPR
23 33 00	Air distribution, adjustable damper plaque	Identity		Yes	233300-002 ADJ DMPR Plaque



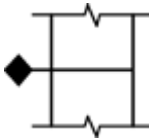
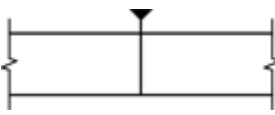

Division 23 –Heating, Ventilating, and Air Conditioning					
Master Format No.	Description	Type	Symbol	NCS Symbol	File Name (.dwg)
23 33 00	Air distribution, barometric damper	Identity		Yes	233300-003 Barometric DMPR
23 33 00	Air distribution, ductwork cowl (gooseneck)	Identity		Yes	233300-004 Ductwork Cowl
23 33 00	Air distribution, ductwork sound attenuator	Identity		Yes	233300-005 Sound Attenuator
23 33 00	Air distribution, fire and smoke damper	Identity		Yes	233300-006 Fire SDMPR
23 33 00	Air distribution, fire damper	Identity		Yes	233300-007 FDMPR

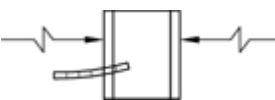
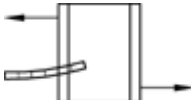

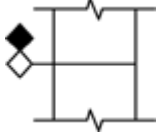
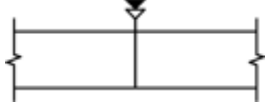
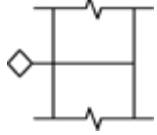
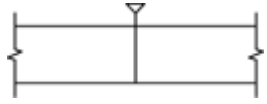
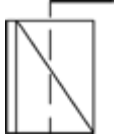
Division 23 –Heating, Ventilating, and Air Conditioning					
Master Format No.	Description	Type	Symbol	NCS Symbol	File Name (.dwg)
23 33 00	Air distribution, flow switch	Identity		Yes	233300-008 Flow SWCH
23 33 00	Air distribution, orifice flowmeter	Identity		Yes	233300-009 F METER
23 33 00	Air distribution, smoke damper	Identity		Yes	233300-010 SDMPR
23 33 00	Air distribution, turning vane in ductwork	Identity		Yes	233300-011 Turning Vane
23 33 00	Air distribution, venturi flowmeter	Identity		Yes	233300-012 Venturi F METER

Division 23 –Heating, Ventilating, and Air Conditioning					
Master Format No.	Description	Type	Symbol	NCS Symbol	File Name (.dwg)
23 33 00	Air distribution, water heater direct contact feed	Identity		Yes	233300-013 Direct Contact Feed
23 33 00	Damper, back draft	Identity		Yes	233300-014 Back Draft
23 33 00	Damper, fire	Identity		Yes	233300-015 DMPR
23 33 00	Ductwork, direction of flow	Identity		Yes	233300-016 Direction of Flow
23 33 00	Ductwork, flexible connector	Identity		Yes	233300-017 FLEX Connector



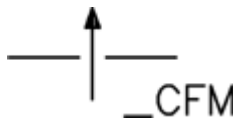

Division 23 –Heating, Ventilating, and Air Conditioning					
Master Format No.	Description	Type	Symbol	NCS Symbol	File Name (.dwg)
23 33 00	Fire damper (horizontal orientation in rectangular duct)	Identity		Yes	233300-018 FDMPR
23 33 00	Fire damper (vertical orientation in rectangular duct)	Identity		Yes	233300-019 FDMPR
23 33 00	Heat stop, fire-rated ceiling	Identity		Yes	233300-020 Fire Rated Ceiling
23 33 00	Light troffer inlet, return air	Identity		Yes	233300-021 Return Air
23 33 00	Light troffer outlet, supply air	Identity		Yes	233300-022 Supply Air

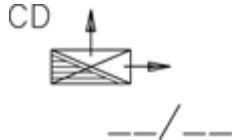
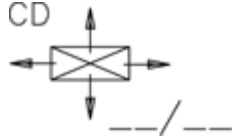

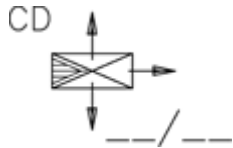
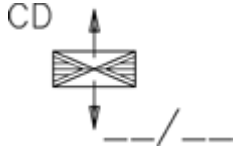
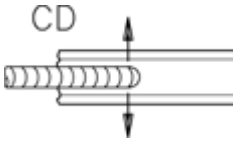
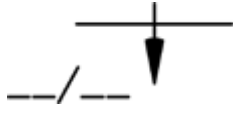

Division 23 –Heating, Ventilating, and Air Conditioning					
Master Format No.	Description	Type	Symbol	NCS Symbol	File Name (.dwg)
23 33 00	Smoke and fire damper (horizontal orientation in rectangular duct)	Identity		Yes	233300-023 FDMPR & SDMPR
23 33 00	Smoke and fire damper (vertical orientation in rectangular duct)	Identity		Yes	233300-024 FDMPR & SDMPR
23 33 00	Smoke damper (horizontal orientation in rectangular duct)	Identity		Yes	233300-025 SDMPR HORIZ
23 33 00	Smoke damper (vertical orientation in rectangular duct)	Identity		Yes	233300-026 SDMPR VERT
23 33 00	Spin-in with volume damper	Identity		Yes	233300-027 Volume Damper

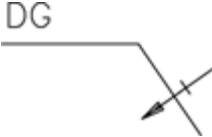

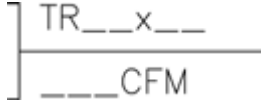

Division 23 –Heating, Ventilating, and Air Conditioning					
Master Format No.	Description	Type	Symbol	NCS Symbol	File Name (.dwg)
23 33 00	Spin-in without volume damper	Identity		Yes	233300-028 Without Volume Damper
23 34 00	Air distribution, centrifugal fan pump	Identity		Yes	233400-001 Fan Pump
23 34 00	Air distribution, duct fan	Identity		Yes	233400-002 Duct Fan
23 34 00	Air distribution, fan	Identity		Yes	233400-003 Fan
23 34 00	Fan, axial flow	Identity		Yes	233400-004 AX FL

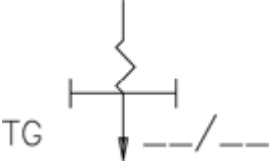
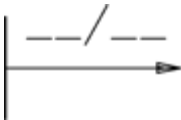

Division 23 –Heating, Ventilating, and Air Conditioning					
Master Format No.	Description	Type	Symbol	NCS Symbol	File Name (.dwg)
23 37 00	Air distribution, ventilation openings	Identity		Yes	233700-001 VENT Opening
23 37 00	Damper, standard branch, return	Identity		Yes	233700-002 DMPR RTRN
23 37 00	Damper, standard branch, supply	Identity		Yes	233700-003 DMPR Supply
23 37 00	Diffuser, ceiling, corner blow	Identity		Yes	233700-004 DIFF
23 37 00	Diffuser, ceiling, four-way, rectangular or square	Identity		Yes	233700-005 DIFF REC or SQ

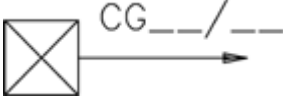
Division 23 –Heating, Ventilating, and Air Conditioning					
Master Format No.	Description	Type	Symbol	NCS Symbol	File Name (.dwg)
23 37 00	Diffuser, ceiling, round	Identity		Yes	233700-006 DIFF Round
23 37 00	Diffuser, ceiling, three-way rectangular or square	Identity		Yes	233700-007 DIFF Three Way
23 37 00	Diffuser, ceiling, two-way rectangular or square	Identity		Yes	233700-008 DIFF Two Way
23 37 00	Diffuser, ceiling, with combination light	Identity		Yes	233700-009 DIFF COMBO Light
23 37 00	Diffuser, linear	Identity		Yes	233700-010 DIFF Linear

Division 23 –Heating, Ventilating, and Air Conditioning					
Master Format No.	Description	Type	Symbol	NCS Symbol	File Name (.dwg)
23 37 00	Diffuser, linear slot supply	Identity		Yes	233700-011 DIFF Linear Slot SPLY
23 37 00	Diffuser, side wall supply	Identity		Yes	233700-012 DIFF Side Wall SPLY
23 37 00	Door grille	Identity		Yes	233700-013 Door Grille
23 37 00	Ductwork, ceiling	Identity		Yes	233700-014 Ceiling Ductwork
23 37 00	Ductwork, exhaust inlet wall	Identity		Yes	233700-015 Exhaust Inlet Wall

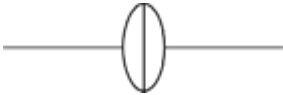

Division 23 –Heating, Ventilating, and Air Conditioning					
Master Format No.	Description	Type	Symbol	NCS Symbol	File Name (.dwg)
23 37 00	Ductwork, return air ceiling	Identity		Yes	233700-016 Return Air Ceiling
23 37 00	Ductwork, supply air ceiling	Identity		Yes	233700-017 Supply Air Ceiling
23 37 00	Grille, transfer	Identity		Yes	233700-018 Grille XFER
23 37 00	Louver, door or wall opening	Identity		Yes	233700-019 LVDR Opening
23 37 00	Louver, intake and screen	Identity		Yes	233700-020 LVR Screen

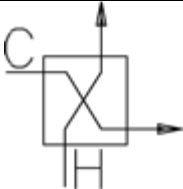
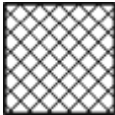

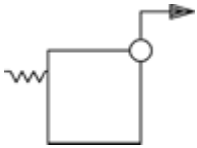
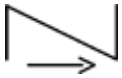
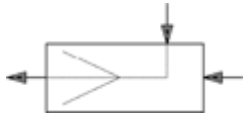
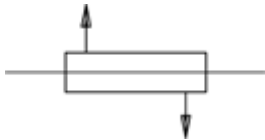
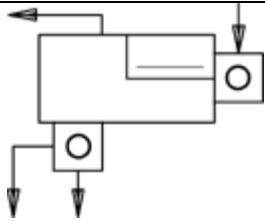
Division 23 –Heating, Ventilating, and Air Conditioning					
Master Format No.	Description	Type	Symbol	NCS Symbol	File Name (.dwg)
23 37 00	Register grille, ceiling supply	Identity		Yes	233700-021 Register Grille
23 37 00	Register grille, side wall supply	Identity		Yes	233700-022 Register Grille Side Wall SPLY
23 37 00	Return air grille with sound boot	Identity		Yes	233700-023 RET Air Grille
23 40 00	Air distribution, automatic filter panel	Identity		Yes	234000-001 AUTO Filter PNL
23 40 00	Air distribution, filter and dehumidifier	Identity		Yes	234000-002 Filter & Dehumidifier



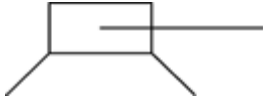
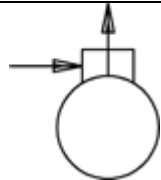
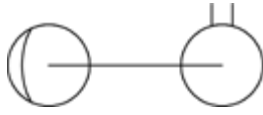

Division 23 –Heating, Ventilating, and Air Conditioning					
Master Format No.	Description	Type	Symbol	NCS Symbol	File Name (.dwg)
23 40 00	Air distribution, filter line	Identity		Yes	234000-003 Filter Line
23 50 00	Heater, flue gas reheater	Identity		Yes	235000-001 Gas Reheater
23 50 00	Piping, flat plate heat exchanger	Identity		Yes	235000-002 Heat EXCH
23 50 00	Piping, plate fin cross flow	Identity		Yes	235000-003 Piping Cross Flow
23 52 00	Equipment, boiler	Identity		Yes	235200-001 EQUIP Boiler

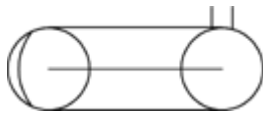
Division 23 –Heating, Ventilating, and Air Conditioning					
Master Format No.	Description	Type	Symbol	NCS Symbol	File Name (.dwg)
23 52 00	Generator, steam	Identity		Yes	235200-002 GEN Steam
23 52 00	Heat-generation equipment, check valve	Identity		Yes	235200-003 GEN EQUIP Check Valve
23 55 00	Heater, desuperheater	Identity		Yes	235500-001 Desuperheater
23 57 00	HVAC equipment, heat exchanger	Identity		Yes	235700-001 Heat EXCH
23 57 00	HVAC equipment, intercooler desuperheater	Identity		Yes	235700-002 Intercooler Dsuperheater

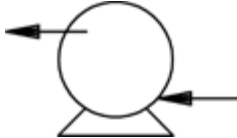
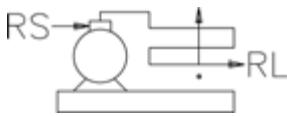
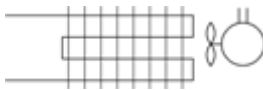

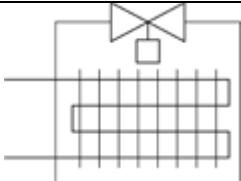
Division 23 –Heating, Ventilating, and Air Conditioning					
Master Format No.	Description	Type	Symbol	NCS Symbol	File Name (.dwg)
23 57 00	Piping, pipe heat	Identity		Yes	235700-003 Piping Heat
23 61 00	Refrigeration equipment, centrifugal compressor	Identity		Yes	236100-001 REFR EQUIP COMPR
23 61 00	Refrigeration equipment, chilling centrifugal unit	Identity		Yes	236100-002 REFR EQUIP Chill Unit
23 61 00	Refrigeration equipment, chilling reciprocating unit	Identity		Yes	236100-003 REFR EQUIP Chill Unit
23 61 00	Refrigeration equipment, chilling rotary screw unit	Identity		Yes	236100-004 REFR EQUIP Screw Unit

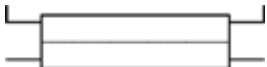
Division 23 –Heating, Ventilating, and Air Conditioning					
Master Format No.	Description	Type	Symbol	NCS Symbol	File Name (.dwg)
23 61 00	Refrigeration equipment, compressor, motor enclosed, reciprocating	Identity		Yes	236100-005 REFR EQUIP COMPR
23 61 00	Refrigeration equipment, compressor, open crankcase, reciprocating	Identity		Yes	236100-007 REFR EQUIP Crank Case
23 61 00	Refrigeration equipment, compressor, reciprocating	Identity		Yes	236100-008 REFR EQUIP COMPR Reciprocating
23 61 00	Refrigeration equipment, compressor, rotary motor encased	Identity		Yes	236100-009 REFR EQUIP COMPR Rotary MOT
23 61 00	Refrigeration equipment, compressor, rotary motor enclosed with crank belt	Identity		Yes	236100-010 REFR EQUIP COMPR Rotary MOT

Division 23 –Heating, Ventilating, and Air Conditioning					
Master Format No.	Description	Type	Symbol	NCS Symbol	File Name (.dwg)
23 61 00	Refrigeration equipment, compressor, rotary motor sealed	Identity		Yes	236100-011 REFR EQUIP COMPR Rotary MOT
23 61 00	Refrigeration equipment, open crankcase, reciprocating	Identity		Yes	236100-012 REFR EQUIP Open Crank Case
23 61 00	Refrigeration equipment, rotary compressor	Identity		Yes	236100-013 REFR EQUIP Rotary COMPR
23 63 00	Refrigeration equipment, air-cooled condensing unit	Identity		Yes	236300-001 REFR EQUIP Air Cooled
23 63 00	Refrigeration equipment, air-cooled fin condenser, forced air	Identity		Yes	236300-002 REFR EQUIP Forced Air

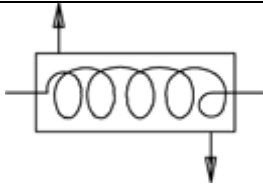
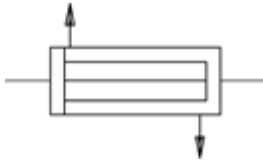
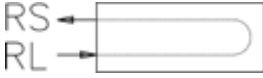
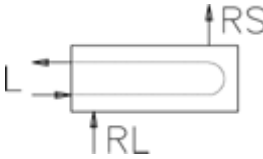

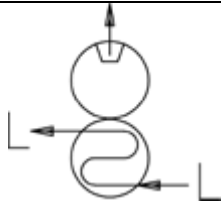
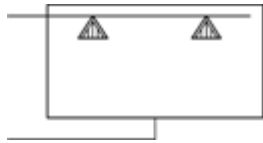
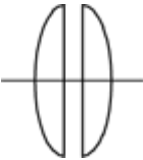

Division 23 –Heating, Ventilating, and Air Conditioning					
Master Format No.	Description	Type	Symbol	NCS Symbol	File Name (.dwg)
23 63 00	Refrigeration equipment, air-cooled fin condenser, static	Identity		Yes	236300-003 REFR EQUIP Static
23 63 00	Refrigeration equipment, condenser surface	Identity		Yes	236300-004 REFR EQUIP COND SURF
23 63 00	Refrigeration equipment, double bundle condenser	Identity		Yes	236300-005 REFR EQUIP DBL COND
23 63 00	Refrigeration equipment, evaporative condenser	Identity		Yes	236300-006 REFR EQUIP EVAP COND
23 63 00	Refrigeration equipment, water cooled condenser	Identity		Yes	236300-007 REFR EQUIP Water COOL COND

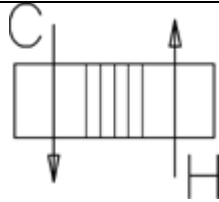
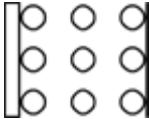
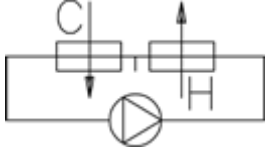
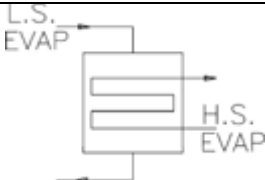
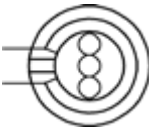

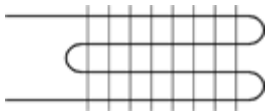
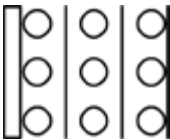
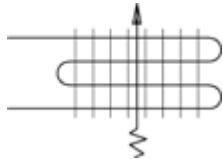
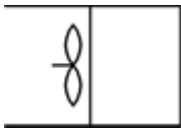
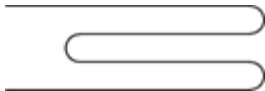

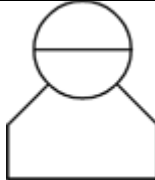
Division 23 –Heating, Ventilating, and Air Conditioning					
Master Format No.	Description	Type	Symbol	NCS Symbol	File Name (.dwg)
23 63 00	Refrigeration equipment, water cooled condensing unit	Identity		Yes	236300-008 REFR EQUIP COND Unit
23 63 00	Refrigeration equipment, water cooled shell/coil condenser	Identity		Yes	236300-009 REFR EQUIP Cooled COND
23 63 00	Refrigeration equipment, water cooled shell/tube condenser	Identity		Yes	236300-010 REFR EQUIP Cooled COND
23 64 00	Chiller, liquid direct expansion	Identity		Yes	236400-001 Chiller EXP
23 64 00	Chiller, liquid flooded	Identity		Yes	236400-002 Chiller Liquid Flooded

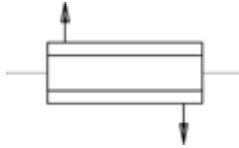
Division 23 –Heating, Ventilating, and Air Conditioning					
Master Format No.	Description	Type	Symbol	NCS Symbol	File Name (.dwg)
23 64 00	Chiller tank, closed, liquid	Identity		Yes	236400-003 Chiller Tank
23 64 00	Chiller tank, open, liquid	Identity		Yes	23640000-04 Chiller Tank
23 64 00	Refrigeration equipment, chilling absorption unit	Identity		Yes	236400-005 REFR EQUIP ABSORB Unit
23 65 00	Refrigeration equipment, cooling tower	Identity		Yes	236500-001 REFR EQUIP COOL Tower
23 70 00	HVAC equipment, drive fluid	Identity		Yes	237000-001 HVAC EQUIP









Division 23 –Heating, Ventilating, and Air Conditioning					
Master Format No.	Description	Type	Symbol	NCS Symbol	File Name (.dwg)
23 72 00	HVAC control, rotary heat wheel	Identity		Yes	237200-001 HVAC Control
23 76 00	Refrigeration equipment, bare tube gravity air evaporator	Identity		Yes	237600-001 REFR EQUIP
23 76 00	Refrigeration equipment, coil loop	Identity		Yes	237600-002 REFR EQUIP Coil Loop
23 76 00	Refrigeration equipment, condenser evaporator cascade system	Identity		Yes	237600-003 REFR EQUIP COND EVAP
23 76 00	Refrigeration equipment, evaporator, finned circular ceiling	Identity		Yes	237600-004 REFR EQUIP EVAP CEILING

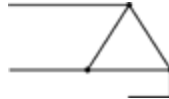





Division 23 –Heating, Ventilating, and Air Conditioning					
Master Format No.	Description	Type	Symbol	NCS Symbol	File Name (.dwg)
23 76 00	Refrigeration equipment, evaporator, finned coil natural convection	Identity		Yes	237600-005 REFR EQUIP EVAP Convection
23 76 00	Refrigeration equipment, evaporator, finned gravity air	Identity		Yes	237600-006 REFR EQUIP EVAP
23 76 00	Refrigeration equipment, evaporator, forced convection	Identity		Yes	237600-007 REFR EQUIP EVAP Convection
23 76 00	Refrigeration equipment, evaporator, forced convection cool unit	Identity		Yes	237600-008 REFR EQUIP EVAP Cool Unit
23 76 00	Refrigeration equipment, evaporator, pipe coil	Identity		Yes	237600-009 REFR EQUIP Pipe Coil

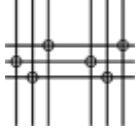
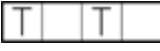

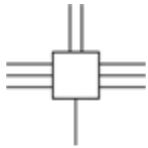

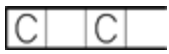

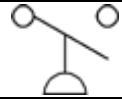
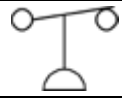

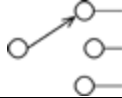
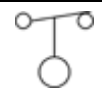
Division 23 –Heating, Ventilating, and Air Conditioning					
Master Format No.	Description	Type	Symbol	NCS Symbol	File Name (.dwg)
23 76 00	Refrigeration equipment, evaporator, plate coil	Identity		Yes	237600-010 REFR EQUIP Plate Coil
23 76 00	Refrigeration equipment, immersion cool unit	Identity		Yes	237600-011 REFR EQUIP Cool Unit
23 76 00	Refrigeration equipment, plate coil head or manifold evaporator	Identity		Yes	237600-012 REFR EQUIP Manifold EVAP
23 76 00	Refrigeration equipment, water cooled concentric tube condenser	Identity		Yes	237600-013 REFR EQUIP CONC COND
23 80 00	Electrical, heater, electric resistance	Identity		Yes	238000-001 ELEC HEATER







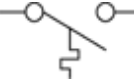

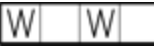
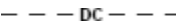
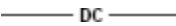

Division 23 –Heating, Ventilating, and Air Conditioning					
Master Format No.	Description	Type	Symbol	NCS Symbol	File Name (.dwg)
23 81 00	HVAC equipment, room air conditioning equipment	Identity		Yes	238100-001 HVAC EQUIP AIR COND
23 82 00	heating, mixing terminal unit	Identity		Yes	238200-001 Heating Mixing Terminal Unit
23 82 00	heating, reheat terminal unit	Identity		Yes	238200-002 Heating Terminal Unit
23 82 00	heating, unit (indicate type)	Identity		Yes	238200-003 Heating Unit
23 82 00	heating, variable volume terminal unit, reheat	Identity		Yes	238200-004 Heating VAV









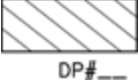

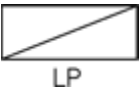

Division 23 –Heating, Ventilating, and Air Conditioning					
Master Format No.	Description	Type	Symbol	NCS Symbol	File Name (.dwg)
23 84 00	dehumidifier	Identity		Yes	238400-001 Dehumidifier













Division 26– Electrical					
Master Format No.	Description	Type	Symbol	NCS Symbol	File Name (.dwg)
26 00 00	Electrical, delta connection	Identity		Yes	260000-001 ELEC Connection
26 00 00	Electrical, motor, single-phase	Identity		Yes	260000-002 ELEC MOT SNGL
26 00 00	Electrical, motor, three-phase	Identity		Yes	260000-003 ELEC MOT 3 Phase
26 00 00	Electrical, transformer, one-line diagram	Identity		Yes	260000-004 ELEC XFMR DIAG
26 00 00	Electrical, transformer, plan	Identity		Yes	260000-005 ELEC XFMR Plan
26 00 00	Traffic Pedestal	Identity		No	260000-007 Traffic PED
26 00 00	Traffic Manhole	Identity		No	260000-008 Traffic MH
26 00 00	Electrical, wye connection	Identity		Yes	260000-006 ELEC Connection
26 05 00	Electrical, duct, cell floor header	Identity		Yes	260500-001 ELEC Duct
26 05 00	Electrical, duct, trolley	Identity		Yes	260500-002 ELEC Trolley









Division 26– Electrical					
Master Format No.	Description	Type	Symbol	NCS Symbol	File Name (.dwg)
26 05 00	Electrical, duct, under floor junction box	Identity		Yes	260500-003 ELEC JBOX
26 05 00	Electrical, earth ground	Identity		Yes	260500-004 ELEC GRND
26 05 00	Electrical, junction box	Identity		Yes	260500-005 ELEC JBOX
26 05 00	Electrical, ladder cable tray	Identity		Yes	260500-006 ELEC Cable Tray
26 05 00	Electrical, panelboard, home run to (arrowheads indicate the number of circuits)	Identity		Yes	260500-007 ELEC EP
26 05 00	Electrical, pressure switch-close on increase	Identity		Yes	260500-008 ELEC PRESS SW Close
26 05 00	Electrical, pressure switch-open on increase	Identity		Yes	260500-009 ELEC PRESS SW Open
26 05 00	Electrical, pull box	Identity		Yes	260500-010 ELEC PB
26 05 00	Electrical, switch, multiposition	Identity		Yes	260500-011 ELEC SWCH Multi POS
26 05 00	Electrical, switch, normally closed float	Identity		Yes	260500-012 ELEC SWCH NC

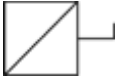
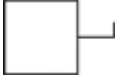





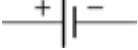
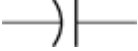

Division 26– Electrical					
Master Format No.	Description	Type	Symbol	NCS Symbol	File Name (.dwg)
26 05 00	Electrical, switch, normally closed foot operated	Identity		Yes	260500-013 ELEC SWCH NC
26 05 00	Electrical, switch, normally closed limit	Identity		Yes	260500-014 ELEC SWCH NC LIM
26 05 00	Electrical, switch, normally closed temperature activated	Identity		Yes	260500-015 ELEC SWCH NC TEMP Activated
26 05 00	Electrical, switch, normally closed time delay	Identity		Yes	260500-016 ELEC SWCH NC Delay
26 05 00	Electrical, switch, normally open float	Identity		Yes	260500-017 ELEC SWCH NO Float
26 05 00	Electrical, switch, normally open limit	Identity		Yes	260500-018 ELEC SWCH NO LIM
26 05 00	Electrical, switch, normally open temperature activated	Identity		Yes	260500-019 ELEC SWCH NO TEMP
26 05 00	Electrical, switch, normally open time delay	Identity		Yes	260500-020 ELEC SWCH NO Delay
26 05 00	Electrical, switch, single break	Identity		Yes	260500-021 ELEC SWCH SNGL Break
26 05 00	Electrical, wireway	Identity		Yes	260500-022 ELEC WW
26 05 00	Direct current underground = DC; thin dash line, 2.5mm (3/32") text	Line		Yes	N/A
26 05 00	Direct current aboveground = DC; thin line, 2.5mm (3/32") text	Line		Yes	N/A



Division 26– Electrical					
Master Format No.	Description	Type	Symbol	NCS Symbol	File Name (.dwg)
26 05 00	Rigid conduit line = RC; thin line, 2.5 mm (3/32") text	Line		Yes	N/A
26 09 00	Electrical, meter	Identity		Yes	260900-001 ELEC Meter
26 10 00	Electrical, substation	Identity		Yes	261000-001 ELEC Substation
26 20 00	Electrical, busway	Identity		Yes	262000-001 ELEC Busway
26 20 00	Electrical, floor outlet, data communication	Identity		Yes	262000-002 ELEC FLOUTS
26 20 00	Electrical, fuse with rating	Identity		Yes	262000-003 ELEC Fuse
26 20 00	Electrical, normally closed relay contact	Identity		Yes	262000-004 ELEC NC Relay
26 20 00	Electrical, normally open relay contact	Identity		Yes	262000-005 ELEC NO Relay
26 20 00	Electrical, outlet, data communication	Identity		Yes	262000-006 ELEC Outlet
26 20 00	Electrical, push button	Identity		Yes	262000-007 ELEC Push Button
26 24 00	Electrical, distribution panel	Identity		Yes	262400-001 ELEC DISTR PNL

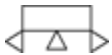

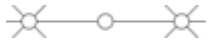



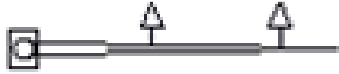

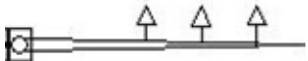
Division 26– Electrical					
Master Format No.	Description	Type	Symbol	NCS Symbol	File Name (.dwg)
26 24 00	Electrical, lighting panel	Identity		Yes	262400-002 ELEC LTG PNL
26 24 00	Electrical, panelboard cabinet, flush mounted	Identity		Yes	262400-003 ELEC PB Flush
26 24 00	Electrical, panelboard cabinet, surface mounted	Identity		Yes	262400-004 ELEC PB Surface
26 24 00	Electrical, power panel	Identity		Yes	262400-005 ELEC PWR PNL
26 27 00	Electrical, receptacle, clock hanger	Identity		Yes	262700-001 ELEC Receptacle
26 27 00	Electrical, receptacle, duplex	Identity		Yes	262700-002 ELEC Duplex
26 27 00	Electrical, receptacle, duplex on emergency power	Identity		Yes	262700-003 ELEC EMER PWR
26 27 00	Electrical, receptacle, duplex with ground fault circuit interrupter	Identity		Yes	262700-004 ELEC Receptacle
26 27 00	Electrical, receptacle, quadraplex	Identity		Yes	262700-005 ELEC Quadraplex
26 27 00	Electrical, receptacle, single	Identity		Yes	262700-006 ELEC SNGL
26 27 00	Electrical, receptacle, single with switch	Identity		Yes	262700-007 ELEC SNGL W_SWCH
26 27 00	Electrical, receptacle, special purpose	Identity		Yes	262700-008 ELEC Receptacle Special

Division 26– Electrical					
Master Format No.	Description	Type	Symbol	NCS Symbol	File Name (.dwg)
26 27 00	Electrical, receptacle, switched duplex	Identity		Yes	262700-009 ELEC Receptacle Duplex
26 27 00	Electrical, switch, ceiling mounted pull	Identity		Yes	262700-010 ELEC SWCH CLG MTD Pull
26 27 00	Electrical, switch, double pole	Identity		Yes	262700-011 ELEC SWCH DBL Pull
26 27 00	Electrical, switch, four-way	Identity		Yes	262700-012 ELEC SWCH 4WAY
26 27 00	Electrical, switch, key operated	Identity		Yes	262700-013 ELEC SWCH Key Operated
26 27 00	Electrical, switch, lamp holder pole	Identity		Yes	262700-014 ELEC SWCH Lamp
26 27 00	Electrical, switch, low voltage master	Identity		Yes	262700-015 ELEC SWCH LV
26 27 00	Electrical, switch, single pole	Identity		Yes	262700-016 ELEC SWCH 1P
26 27 00	Electrical, switch, three-way	Identity		Yes	262700-017 ELEC SWCH 3WAY
26 27 00	Electrical, switch, timer operated	Identity		Yes	262700-018 ELEC SWCH Timer
26 27 00	Electrical, switch with pilot light	Identity		Yes	262700-019 ELEC SWCH Pilot LT
26 28 00	Electrical, circuit breaker	Identity		Yes	262800-001 ELEC CKT BRKR



Division 26– Electrical					
Master Format No.	Description	Type	Symbol	NCS Symbol	File Name (.dwg)
26 28 00	Electrical, disconnect switch, fused	Identity		Yes	262800-002 ELEC DS FU SW
26 28 00	Electrical, disconnect switch, unfused	Identity		Yes	262800-003 ELEC DS NFSD
26 28 00	Electrical, fused switch	Identity		Yes	262800-004 ELEC FU SW
26 28 00	Electrical, fusible link	Identity		Yes	262800-005 ELEC FUS LINK
26 29 00	Electrical, starter, combination with disconnect switch	Identity		Yes	262900-001 ELEC Starter DS NFSD
26 29 00	Electrical, starter or motor controller	Identity		Yes	262900-002 ELEC Starter
26 29 00	Electrical, time clock	Identity		Yes	262900-003 ELECT Time Clock
26 32 00	Electrical, generator, power	Identity		Yes	263200-001 ELEC GEN
26 33 00	Electrical, battery	Identity		Yes	263300-001 ELEC BAT
26 35 00	Electrical, capacitor	Identity		Yes	263500-001 ELEC CAP
26 41 00	Lightning arrester	Identity		Yes	264100-001 Lightning Arrester
26 50 00	Lighting, incandescent ceiling mounted	Identity		Yes	265000-001 Lighting INCAND

Division 26– Electrical					
Master Format No.	Description	Type	Symbol	NCS Symbol	File Name (.dwg)
26 51 00	Electrical, light fixture, surface mounted fluorescent B, 300 mm x 1200 mm (1x4)	Identity		Yes	265100-005 ELEC LT FIXT FLUOR B
26 51 00	Electrical, light fixture, surface mounted fluorescent C, 300 mm x 2400 mm (1x8)	Identity		Yes	265100-006 ELEC LT FIXT FLUOR C
26 52 00	Electrical, exit sign, wall mounted light	Identity		Yes	265200-001 ELEC EXT LT
26 52 00	Electrical, light fixture, fluorescent emergency	Identity		Yes	265200-002 ELEC LT FIXT EMER
26 52 00	Lighting, one emergency battery power	Identity		Yes	265200-003 LT EMER BAT PWR
26 52 00	Lighting, three emergency battery power	Identity		Yes	265200-004 LT 3 EMER BAT PWR
26 56 00	Electrical, street light with bracket	Identity		Yes	265600-001 ELEC ST LT BRKT
26 56 00	Light post, one arm, one head	Identity		Yes	265600-002 Light Post 1 Arm 1 Head
26 56 00	Light post, two arms, two heads	Identity		Yes	265600-003 Light Post 2 Arms 2 Heads
26 56 00	Light post without arm, Yard light	Identity		Yes	265600-004 Light Post wo Arm
26 56 00	Lighting, exterior building	Identity		Yes	265600-007 LT Exterior BLDG

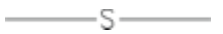
Division 26– Electrical					
Master Format No.	Description	Type	Symbol	NCS Symbol	File Name (.dwg)
26 56 00	Traffic signal -2 lights	Identity		No	265600-009 Traffic Signal 2 LT
26 56 00	Traffic signal – 1 light	Identity		No	265600-010 Traffic Signal 1 LT
26 56 00	Traffic signal – 3 lights	Identity		No	265600-011 Traffic Signal 3 LT

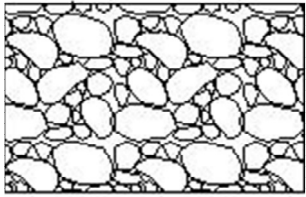
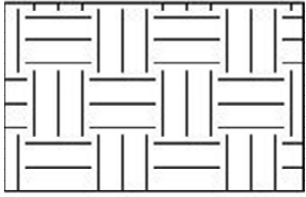
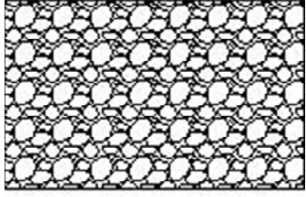

Division 27– Communications					
Master Format No.	Description	Type	Symbol	NCS Symbol	File Name (.dwg)
27 05 00	Outlet, combination telephone/data communication	Identity		Yes	270500-001 OUT COMBO COMM
27 05 00	Satellite dish	Identity		No	270500-002 Satellite Dish
27 30 00	Electrical, floor receptacle, telephone	Identity		Yes	273000-01 ELEC RECPT TELE
27 30 00	Telephone, wall mounted	Identity		Yes	273000-02 TELE Wall MTD
27 40 00	Electrical, speaker, ceiling mounted, X indicates type, provide schedule on legend	Identity		Yes	274000-01 ELEC SPKR CLG MTD
27 40 00	Electrical, speaker, wall mounted, "X" indicates the type, provide schedule on legend	Identity		Yes	274000-02 ELEC SPKR Wall MTD
27 30 00	Overhead telephone line	Line		No	N/A
27 30 00	Underground telephone line	Line		No	N/A
27 51 00	Intercom line = I; thin line, 2.5 mm (3/32") text	Line		Yes	N/A
27 51 00	Sound line = S; thin line, 2.5 mm (3/32") text	Line		Yes	N/A



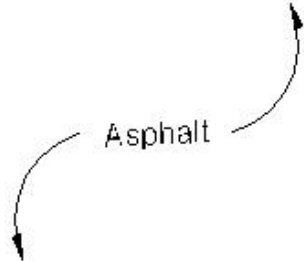
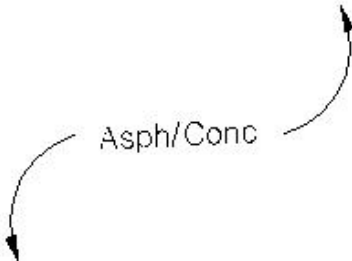
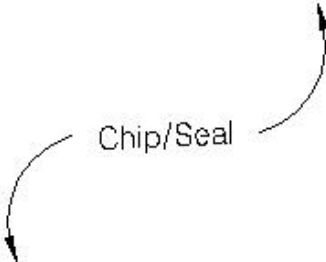

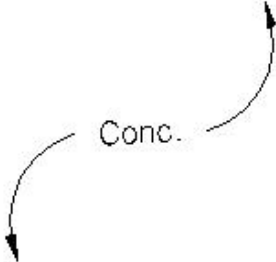
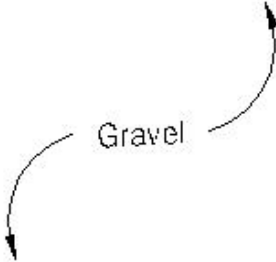
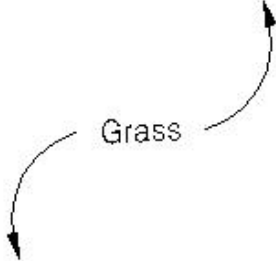
Division 27– Communications					
Master Format No.	Description	Type	Symbol	NCS Symbol	File Name (.dwg)
27 10 00	Overhead fiber optic line	Line	———— OHFIB ————	No	N/A
27 10 00	Underground fiber optic line	Line	———— UGFIB ————	No	N/A
27 10 00	Overhead cable tv line	Line	———— OHCATV ————	No	N/A
27 10 00	Underground cable tv line	Line	———— UGCATV ————	No	N/A

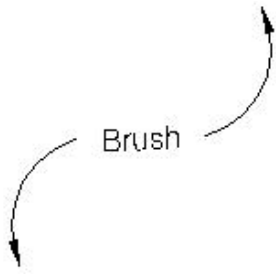
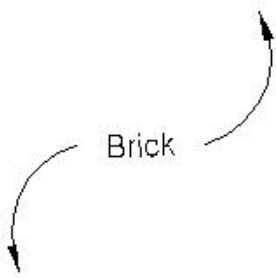

Division 31 -Earthwork					
Master Format No.	Description	Type	Symbol	NCS Symbol	File Name (.dwg)
31 35 00	Erosion control, silt fence	Line		No	N/A
31 37 00	Riprap	Material		No	N/A
31 20 00	Earth	Material		No	N/A
31 20 00	Gravel	Material		No	N/A
31 20 00	Undisturbed earth	Material		No	N/A

Division 32 –Exterior Improvements					
Master Format No.	Description	Type	Symbol	NCS Symbol	File Name (.dwg)
32 01 00	Asphalt indicator	Text		No	320100-001 ASPH Indicator
32 01 00	Asphalt/Concrete indicator	Text		No	320100-002 ASPH CONC Indicator
32 01 00	Chip & Seal indicator	Text		No	320100-003 Chip Seal Indicator





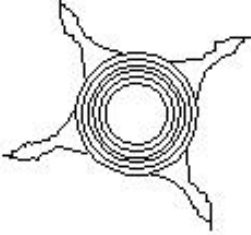
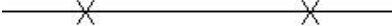

Division 32 –Exterior Improvements					
Master Format No.	Description	Type	Symbol	NCS Symbol	File Name (.dwg)
32 01 00	Concrete indicator	Text		No	320100-004 CONC Indicator
32 01 00	Gravel indicator	Text		No	320100-005 Gravel Indicator
32 01 00	Grass indicator	Text		No	320100-006 Grass Indicator

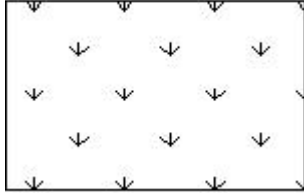
Division 32 –Exterior Improvements					
Master Format No.	Description	Type	Symbol	NCS Symbol	File Name (.dwg)
32 01 00	Brush indicator	Text		No	32100-007 Brush Indicator
32 01 00	Brick Indicator	Text		No	32100-008 Brick Indicator
32 17 00	Shared roadway bicycle marking	Identity		No	321700-001 Bike Marking

Division 32 –Exterior Improvements					
Master Format No.	Description	Type	Symbol	NCS Symbol	File Name (.dwg)
32 17 00	ADA handicap	Identity		No	321700-002 HC
32 17 00	Parking block	Identity		No	321700-003 PRKG Block
32 93 00	Bush	Object		No	329300-002 Bush
32 93 00	Tree, Deciduous	Object		No	329300-003 Deciduous Tree



Division 32 –Exterior Improvements					
Master Format No.	Description	Type	Symbol	NCS Symbol	File Name (.dwg)
32 93 00	Tree, Evergreen	Object		No	329300-004 Evergreen Tree
32 93 00	Tree, Stump	Object		No	329300-006 Tree Stump
32 31 00	Fence line, Chain Link	Line		No	N/A
32 31 00	Fence line, wood	Line		No	N/A

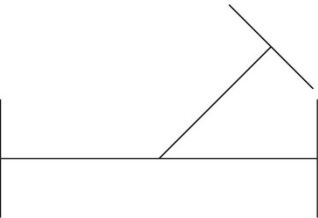

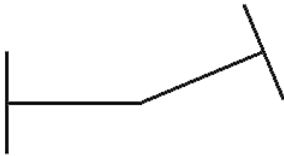
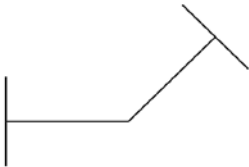
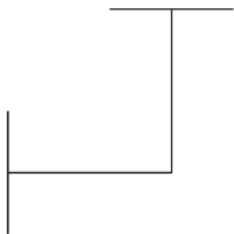

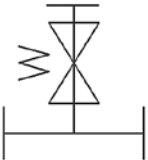
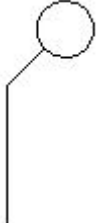
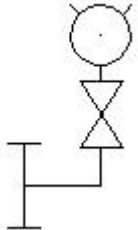
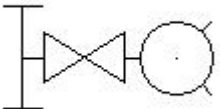

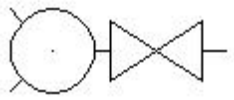
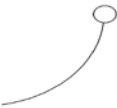
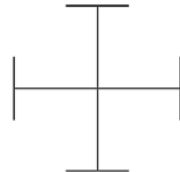

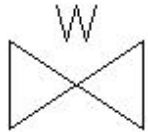
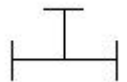
Division 32 –Exterior Improvements					
Master Format No.	Description	Type	Symbol	NCS Symbol	File Name (.dwg)
32 92 00	Grass	Material		No	N/A







Division 33– Utilities					
Master Format No.	Description	Type	Symbol	NCS Symbol	File Name (.dwg)
33 05 00	Utility services, manhole	Identity		Yes	330500-001 UTIL Services MH
33 11 00	Piping, thrust block	Identity		Yes	331100-001 Piping Thrust Block
33 11 00	Utility, water manhole	Identity		Yes	331100-003 UTIL Water MH
33 11 00	Utility, water meter	Identity		Yes	331100-004 UTIL WM
33 11 00	Utility, water tank	Identity		Yes	331100-008 UTIL Water Tank
33 12 00	Hydrant, fire	Identity		Yes	331200-001 Hydrant
33 12 00	Wye	Identity		No	331200-008 Wye







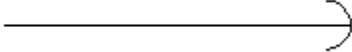

Division 33– Utilities					
Master Format No.	Description	Type	Symbol	NCS Symbol	File Name (.dwg)
33 12 00	Bend-11	Identity		No	331200-009 Bend 11 DEG
33 12 00	Bend-22	Identity		No	331200-010 Bend 22 DEG
33 12 00	Bend-45	Identity		No	331200-011 Bend 45 DEG
33 12 00	Bend-90	Identity		No	331200-012 Bend 90 DEG

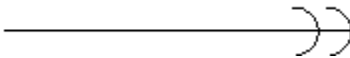

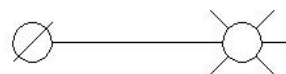

Division 33– Utilities					
Master Format No.	Description	Type	Symbol	NCS Symbol	File Name (.dwg)
33 12 00	Tapping sleeve & valve	Identity		No	331200-013 Tapping Sleeve Valve
33 12 00	Curb box service replacement	Identity		No	331200-014 Curb Box Replacement
33 12 00	Type III hydrant assembly	Identity		No	331200-015 Type 3 HYD Assembly
33 12 00	Type I hydrant assembly	Identity		No	331200-016 Type 1 HYD Assembly

Division 33– Utilities					
Master Format No.	Description	Type	Symbol	NCS Symbol	File Name (.dwg)
33 12 00	Type V hydrant assembly	Identity		No	331200-017 Type 5 HYD Assembly
33 12 00	Water blow off	Identity		No	331200-018 Water BO
33 12 00	Water cross	Identity		No	331200-019 Water Cross
33 12 00	Cut & plug	Identity		No	331200-020 Cut and Plug
33 12 00	Water reducer	Identity		No	331200-021 Water RDCR
33 12 00	Water valve	Identity		No	331200-022 Water Valve
33 12 00	Water Tee	Identity		No	331200-023 Water Tee

Division 33– Utilities					
Master Format No.	Description	Type	Symbol	NCS Symbol	File Name (.dwg)
33 71 00	Unknown water service curb box location	Identity		No	337100-027 UNK Curb box LOC
33 20 00	Well	Identity		No	332000-001 Well
33 30 00	Utility, sanitary manhole	Identity		Yes	333000-001 UTIL SAN MH
33 30 00	Utility, sanitary meter	Identity		Yes	333000-002 UTIL SAN Meter
33 30 00	Utility, sanitary sewer lift station	Identity		Yes	333000-004 UTIL SAN Lift STA
33 36 00	Utility, septic tank	Identity		Yes	333600-001 UTIL SEP TNK
33 39 00	Utility, sanitary cleanout	Identity		Yes	333900-001 UTIL SAN CO
33 44 00	Drainage, catch basin	Identity		Yes	334400-001 CB

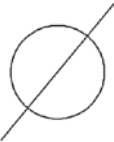
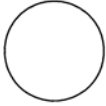
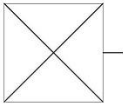
Division 33– Utilities					
Master Format No.	Description	Type	Symbol	NCS Symbol	File Name (.dwg)
33 44 00	Drainage, catch basin, round	Identity		Yes	334400-002 Catch Basin Round
33 49 00	Utility, storm drainage manhole	Identity		Yes	334900-001 UTIL Storm MH
33 49 00	Utility, Storm Inlet	Identity		No	334900-002 UTIL Storm Inlet
33 49 00	Utility, Storm Inlet Round	Identity		No	334900-003 UTIL Storm Inlet Round
33 51 00	Piping, Gas Valve	Identity		No	335100-01 Gas Valve
33 51 00	Utility, manhole, natural gas	Identity		Yes	335100-003 UTIL MH G
33 51 00	Utility, meter, natural gas	Identity		Yes	335100-004 UTIL Meter G
33 70 00	Anchor guy wire – single	Identity		No	337000-001 Guy Wire - Single

Division 33– Utilities					
Master Format No.	Description	Type	Symbol	NCS Symbol	File Name (.dwg)
33 70 00	Anchor guy wire – multiple	Identity		No	337000-002 Guy Wire - Multiple
33 70 00	Electrical, handhole	Identity		Yes	337000-003 ELEC HH
33 70 00	Electrical, transformer, current	Identity		Yes	337000-004 ELEC XFMR
33 71 00	Electrical, aerial service weather head	Identity		Yes	337100-001 ELEC Weather Head
33 71 00	Power pole with one light arm	Identity		Yes	337100-002 Power pole with 1 Light Arm
33 71 00	Utility, distribution switch or switching station	Identity		Yes	337100-003 UTIL Distribution SWCH
33 71 00	Utility, electrical manhole	Identity		Yes	337100-004 UTIL ELEC MH
33 71 00	Utility, primary electrical handhole	Identity		Yes	337100-005 UTIL ELEC HH

Division 33– Utilities					
Master Format No.	Description	Type	Symbol	NCS Symbol	File Name (.dwg)
33 71 00	Power pole	Identity		No	337100-028 Power Pole
33 71 00	Utility pole	Identity		No	337100-029 UP
33 71 00	Electric Utility Transmission Tower	Identity		No	337100-030 ELEC UTIL TWR
33 81 00	Utility, communications manhole	Identity		Yes	338100-001 UTIL COMM MH
33 81 00	Utility, telephone manhole	Identity		Yes	338100-002 UTIL TELE MH
33 81 00	Telephone Pedestal	Identity		No	338100-003 TELE PED
33 81 00	Cable TV Pedestal	Identity		No	338100-004 Cable TV PED





Division 33– Utilities					
Master Format No.	Description	Type	Symbol	NCS Symbol	File Name (.dwg)
33 11 00	Water line, hot = HW; thin line, 2.5 mm (3/32") text	Line	————— HW —————	Yes	N/A
33 11 00	Water line, known size	Line	————— X" W —————	No	N/A
33 11 00	Water line, unknown size	Line	————— W —————	No	N/A
33 11 00	Private water main, unknown size	Line	————— PWM —————	No	N/A
33 11 00	Private water main, known size	Line	————— X" PWM —————	No	N/A
33 50 00	Gas line, known size	Line	————— X" G —————	No	N/A
33 50 00	Gas line, unknown size	Line	————— G —————	No	N/A
33 31 00	Sanitary sewer, unknown size	Line	————— SS —————	Yes	N/A

Division 33– Utilities					
Master Format No.	Description	Type	Symbol	NCS Symbol	File Name (.dwg)
33 31 00	Sanitary sewer line, known size	Line	———— X" SS ————	No	N/A
33 31 00	Force main line, unknown size	Line	———— FM ————	No	N/A
33 31 00	Force main line, known size	Line	———— X" FM ————	No	N/A
33 41 00 `	Storm drainage line, unknown size	Line	———— ST ————	No	N/A
33 41 00	Storm drainage line, known size	Line	———— X" ST ————	No	N/A
33 71 00	Overhead electric line	Line	———— OHEL ————	No	N/A
33 71 00	Underground electric line	Line	———— UGEL ————	No	N/A
33 71 00	Overhead street light line	Line	———— OHSL ————	No	N/A

Division 33– Utilities					
Master Format No.	Description	Type	Symbol	NCS Symbol	File Name (.dwg)
33 71 00	Underground street light line	Line	———— UGSL ————	No	N/A
33 71 00	Overhead Unknown or Misc. Utility Line	Line	———— OHUL ————	No	N/A
33 71 00	Underground Unknown or Misc. Utility Line	Line	———— UGUL ————	No	N/A
33 71 00	Overhead traffic line	Line	———— OHTRAF ————	No	N/A
33 71 00	Underground traffic line	Line	———— UGTRAF ————	No	N/A
33 46 00	Drainage, open tile drain	Identity	== == == ==	Yes	N/A
33 71 00	Electric line, 2-phase primary overhead = 2∅OP; thin line, 2.5 mm (3/32") text	Line	———— 2∅OP ————	Yes	N/A
33 71 00	Electric line, 2-phase primary underground = 2∅UP; thin line, 2.5 mm (3/32") text	Line	———— 2∅UP ————	Yes	N/A

Division 33– Utilities					
Master Format No.	Description	Type	Symbol	NCS Symbol	File Name (.dwg)
33 71 00	Electric line, 2-phase secondary overhead = 2∅OS; thin line, 2.5 mm (3/32") text	Line	——2∅OS——	Yes	N/A
33 71 00	Electric line, 2-phase secondary underground = 2∅US; thin line, 2.5 mm (3/32") text	Line	——2∅US——	Yes	N/A
33 71 00	Electric line, 3-phase primary overhead = 3∅OP; thin line, 2.5 mm (3/32") text	Line	——3∅OP——	Yes	N/A
33 71 00	Electric line, 3-phase primary underground = 3∅UP; thin line, 2.5 mm (3/32") text	Line	——3∅UP——	Yes	N/A
33 71 00	Electric line, 3-phase secondary overhead = 3∅OS; thin line, 2.5 mm (3/32") text	Line	——3∅OS——	Yes	N/A
33 71 00	Electric line, 3-phase secondary underground = 3∅US; thin line, 2.5 mm (3/32") text	Line	——3∅US——	Yes	N/A
33 71 00	Electric line, single phase primary overhead = 1∅OP; thin line, 2.5 mm (3/32") text	Line	——1∅OP——	Yes	N/A
33 71 00	Electric line, single phase primary underground = 1∅UP; thin line, 2.5 mm (3/32") text	Line	——1∅UP——	Yes	N/A

Division 33– Utilities					
Master Format No.	Description	Type	Symbol	NCS Symbol	File Name (.dwg)
33 71 00	Electric line, single phase secondary overhead = 1ØOS; thin line, 2.5 mm (3/32") text	Line	—— 1ØOS ——	Yes	N/A
33 71 00	Electric line, single phase secondary underground = 1ØUS; thin line, 2.5 mm (3/32") text	Line	—— 1ØUS ——	Yes	N/A
33 11 00	Return line, chilled water = CWR; thin line, 2.5 mm (3/32") text	Line	—— CWR ——	Yes	N/A
33 11 00	Supply line, chilled water = CWS; thin line, 2.5 mm (3/32") text	Line	—— CWS ——	Yes	N/A
33 11 00	Water line, cold = CW; thin line, 2.5 mm (3/32") text	Line	—— CW ——	Yes	N/A

Division 34– Transportation					
Master Format No.	Description	Type	Symbol	NCS Symbol	File Name (.dwg)
34 41 00	Traffic Control Barrel/Drum	Identity		No	344100-001 TRAF BARREL
34 41 00	Traffic Control Barricade	Identity	 Barricade ID	No	344100-002 Traffic Control Barricade
34 41 00	Traffic Control Sign	Identity	 Sign ID	No	344100-003 Traffic Control Sign
34 41 00	Arrow Board	Identity		No	344100-004 ARROW BOARD